

GALVANIC

APPLIED SCIENCES

ProTech903W™

CHLORINE ANALYZER

OPERATION MANUAL

Revision 3 – February 2022



Galvanic Applied Sciences, Inc.

7000 Fisher Road S.E.

Calgary, Alberta, T2H 0W3

Canada

Phone: (403) 252-8470

Toll Free: 1-866-252-8470

E-mail: service@galvanic.com

Website: <https://www.galvanic.com>

NOTICES

This system is covered by a limited warranty. A copy of the warranty is included with this manual. The operator is required to perform routine maintenance as described herein on a periodic basis to keep the warranty in effect. For routine maintenance procedures, refer to Section 7.

All information in this manual is subject to change without notice and does not represent a commitment on the part of Galvanic Applied Sciences, Inc.

No part of this manual may be reproduced or transmitted in any form or by any means without the written permission of Galvanic Applied Sciences, Inc.

Note: Changes or modifications not expressly approved by Galvanic Applied Sciences, Inc. could void the user's authority to operate the equipment.

Table of Contents

SECTION 1	CHLORINE ANALYZER	12
1.1	OVERVIEW.....	12
1.2	PRINCIPLE OF OPERATION.....	12
1.3	FEATURES OF THE ANALYZER	13
1.4	SYSTEM OPERATING CONTROL.....	13
1.5	CONTENTS OF THIS MANUAL.....	14
SECTION 2	ANALYZER COMPONENTS	15
2.1	OVERVIEW.....	15
2.2	MOTHERBOARD	16
2.2.1	<i>Description of the Motherboard</i>	16
2.2.2	<i>Boards Associated with the Motherboard</i>	16
2.2.3	<i>AC and DC Power Supply</i>	16
2.3	LCD DISPLAY BOARD, KEYPAD AND LED'S	16
2.3.1	<i>User Interaction Features</i>	16
2.3.2	<i>Display Board Communication Ports</i>	18
2.4	INNER SWING PANEL.....	18
2.5	TAPE TRANSPORT SYSTEM.....	19
2.5.1	<i>Supply and Take-up Reels</i>	19
2.5.2	<i>Pulse Counter</i>	20
2.6	SAMPLE CHAMBER ASSEMBLY	21
2.6.1	<i>Rate/Read Aperture Strip and the Rear Window Assembly</i>	22
2.6.2	<i>Read/Rate Aperture Strip</i>	23
2.6.3	<i>Sensor Block</i>	23
2.6.4	<i>Compression Head</i>	24
2.7	SAMPLE FLOW RELATED COMPONENTS	25
2.7.1	<i>Rotameter</i>	25
2.7.2	<i>Power Vent (Eductor)</i>	25
2.8	SAMPLE CONDITIONING SYSTEM (OPTIONAL)	26
SECTION 3	INSTALLATION.....	28
3.1	RECEIVING THE SYSTEM.....	28
3.2	INSTALLATION REQUIREMENTS	28
3.2.1	<i>Electrical Requirements</i>	28
3.2.2	<i>Location of the System</i>	28
3.2.3	<i>Space Requirements</i>	29
3.2.4	<i>Area Classification Information</i>	30
3.2.5	<i>Gas Requirements</i>	30
3.2.6	<i>External Power Switch</i>	30
3.3	UNPACKING	30
3.4	INSTALLATION OF THE SOFTWARE	31
3.4.1	<i>Computer Requirements</i>	31
3.4.2	<i>Install the Application Software</i>	31
3.4.3	<i>Power up the Analyzer</i>	32
3.4.4	<i>Connect the System to the PC via RS-232</i>	33
3.4.5	<i>Open the Application Program and Set Communication Parameters</i>	34
3.4.5.1	<i>Com Port Direct Option</i>	35
3.4.5.2	<i>Modem Option</i>	35

3.4.5.3	<i>Ethernet Option</i>	36
3.4.5.4	<i>Connect the Computer and the Analyzer</i>	37
3.5	INSTALLING THE KEYPAD AND SENSING TAPE	38
3.5.1	<i>Installing the Keypad</i>	38
3.5.2	<i>Installing the Sensing Tape</i>	38
3.6	CONNECTING GAS TO ANALYZER	41
3.6.1	<i>Connecting Gas to the Analyzer</i>	41
3.6.2	<i>Leak Testing of the Compression Head</i>	41
3.6.3	<i>Connecting the Power Eductor</i>	42
3.7	TESTING THE ANALYZER	43
SECTION 4 OPERATING THE ANALYZER VIA THE HANDHELD KEYPAD		44
4.1	INTRODUCTION	44
4.2	THE FRONT PANEL LED'S	44
4.3	THE MAIN PAGE OF THE LCD DISPLAY	46
4.3.1	<i>Status Indicator Lines</i>	47
4.3.2	<i>Central Region</i>	48
4.3.3	<i>Display Menus and Sub-menus Descriptions</i>	48
4.4	USING THE HANDHELD KEYPAD	49
4.5	THE STREAMS MENU	51
4.6	THE ALARMS PAGE	53
4.7	THE DISPLAY MENU	54
4.7.1	<i>The SQNC Menu</i>	54
4.7.2	<i>IO Menu</i>	54
4.7.3	<i>Analyzer Reading Menu</i>	55
4.7.4	<i>Analyzer Schedule Menu</i>	55
4.8	THE CONFIGURATION MENU	56
4.8.1	<i>The Gen Menu</i>	56
4.8.2	<i>The DIO Menu (Digital Inputs/Outputs)</i>	57
4.8.3	<i>The AIO Menu (Analog Inputs/Outputs)</i>	57
4.8.4	<i>The MSEQ Menu (Manual Sequencer)</i>	58
SECTION 5 GRAPHICAL USER INTERFACE (GUI)		59
5.1	OPENING THE PROGRAM	59
5.2	COMPONENTS OF THE MAIN WINDOW	61
5.2.1	<i>Menu Bar</i>	61
5.2.2	<i>The Tool Bar</i>	62
5.2.2.1	<i>Communicate Toolbar</i>	62
5.2.2.2	<i>Operation Toolbar</i>	63
5.2.2.3	<i>General Toolbar</i>	64
5.2.3	<i>Application Screens (Tabs)</i>	64
5.2.4	<i>Status Bar</i>	65
5.3	COMMUNICATION BETWEEN THE COMPUTER AND THE ANALYZER	66
5.4	THE ANALYSIS TAB	67
5.4.1	<i>Field Names and Explanations</i>	68
5.4.2	<i>Analysis Data</i>	69
5.5	STATUS TAB	70
5.6	ALARMS TAB	71
5.6.1	<i>Global Alarms</i>	72
5.6.2	<i>Analog Input Alarms</i>	73
5.6.3	<i>Analysis Alarms</i>	73
5.7	ARCHIVE TAB	74

5.7.1	The Table Format	74
5.7.2	The Graph Format	75
5.7.3	Filtering Data	78
5.7.3.1	Filtering Data by Date	78
5.7.3.2	Filtering Data Numerically	78
5.7.3.3	Exporting Data	80
5.7.3.4	Log Setup	80
5.8	EVENTS TAB	83
5.9	GLOBAL TAB	85
5.9.1	General	86
5.9.1.1	Tape Field	87
5.9.2	Global Alarms	88
5.9.3	Calibration Gain Calculator	88
5.10	STREAMS TAB	89
5.10.1	Overview	89
5.10.2	Universal Gas Run Commands	91
5.10.3	The Sample Tab	91
5.10.3.1	Timing Commands	91
5.10.3.3	Frequency	93
5.10.3.4	Analog Output Override	93
5.10.3.5	Stream Calibration Used	94
5.10.3.6	Alarms	94
5.10.4	Calibration, Reference and Zero Gas Tabs	95
5.10.4.1	Calibration Tab	95
5.10.4.2	Reference Tab	96
5.10.4.3	Zero Tab	96
5.10.4.4	Differences between the Sample Tab and the Calibration/Reference/Zero Gas Tabs	97
5.11	INPUTS- DRY TAB	98
5.11.1	Discrete Input Name	99
5.11.2	Enable & Alarm Check Boxes	99
5.11.3	Polarity	99
5.11.4	Run Selector	99
5.11.5	Action	99
5.12	INPUTS - WET TAB	100
5.13	OUTPUT TAB	101
5.13.1	Digital Outputs and Solenoids	102
5.13.2	Analog Outputs	102
5.14	SEQUENCER TAB	103
5.14.1	Enables Entire Sequencer Operation Checkbox	104
5.14.2	Available Run Types	104
5.14.3	Sequencer Items	104
5.14.4	Manual Sequencer Request Checkbox	105
5.14.5	Digital Input Manual Sequencer Request Enable Checkbox	105
5.14.6	Manual Sequencer # 1 - 8	106
5.15	PORTS TAB	107
5.16	MODBUS TAB	108
5.16.1	Enron	110
5.16.2	Modicon 16	111
5.16.3	Modicon with Floating Point	111
5.16.4	A Typical Modbus Setup	111
5.17	ANALOG INPUT TAB	113
5.17.1	Analog Input #	113

5.17.2	<i>Analog Input Parameters and Controls</i>	114
5.17.3	<i>Analog Inputs Alarm</i>	114
5.18	TIMERS TAB.....	115
5.18.1	<i>Schedule</i>	116
5.18.2	<i>Analysis</i>	116
5.18.3	<i>Sequences</i>	116
5.19	MAINTENANCE TAB	117
5.19.1	<i>Entering the Calibration Mode</i>	118
5.19.2	<i>Calibrating Analog Outputs</i>	119
5.20	FACTORY TAB.....	120
SECTION 6 OPERATING THE SYSTEM.....		121
6.1	INTRODUCTION	121
6.2	EDITING A CONFIGURATION	121
6.2.1	<i>Accessing the Active Configuration</i>	121
6.2.2	<i>Types of Parameters in a Configuration</i>	122
6.2.3	<i>General Guidelines for Editing Parameters</i>	122
6.3	COMMONLY EDITED PARAMETERS	123
6.3.1	<i>The Streams Tab</i>	123
6.3.2	<i>Sequencer Tab</i>	124
6.4	LESS COMMONLY EDITED ANALYZER PARAMETERS.....	125
6.4.1	<i>The Global Tab</i>	125
6.4.2	<i>Dry and Wet Inputs</i>	126
6.4.3	<i>Outputs Tab</i>	127
6.4.4	<i>The Ports Tab</i>	128
6.4.5	<i>Modbus Tab</i>	129
6.4.6	<i>Timers Tab</i>	130
6.5	CALIBRATING/VALIDATING THE ANALYZER OUTPUTS.....	131
6.6	CALIBRATING/VALIDATING THE ANALYZER.....	132
6.6.1	<i>Manual Calibration</i>	132
6.6.2	<i>Manually Initiated Auto Calibration</i>	133
6.6.3	<i>Auto Calibration</i>	134
6.7	ANALYZING SAMPLES	136
6.8	MONITORING SYSTEM OPERATION.....	138
SECTION 7 MAINTENANCE.....		142
7.1	OVERVIEW.....	142
7.2	ROUTINE MAINTENANCE PROCEDURES	142
7.3	CHANGING THE TAPE	143
7.4	CHECKING THE SAMPLE SYSTEM	146
SECTION 8 TROUBLESHOOTING AND SERVICE.....		147
8.1	OVERVIEW.....	147
8.2	TROUBLESHOOTING MESSAGES AND ALERTS	147
8.3	ALARMS TAB.....	149
8.4	COMMONLY OBSERVED PROBLEMS	152
SECTION 9 ANALYZER Q.C. DOCUMENTATION		154
SECTION 10 CHLORINE ANALYZER WIRING BOOK		157
SECTION 11 TECHNICAL SPECIFICATIONS		166

11.1 PERFORMANCE SPECIFICATIONS	166
11.2 FUNCTIONS.....	166
11.3 COMMUNICATIONS / INTERFACE	167
11.4 INSTRUMENT SPECIFICATIONS	168
SECTION 12 SPARE PARTS	169
SECTION 13 MSDS INFORMATION.....	170
INDEX	171

Safety Symbols used in Manual



The Danger symbol indicates a hazardous situation that, if not avoided will result in death or serious injury.



The Warning symbol indicates a hazardous situation that, if not avoided could result in death or serious injury.



The Caution symbol with the safety alert symbol indicates a hazardous situation that, if not avoided could result in minor or moderate injury.



The Notice symbol is used to highlight information that will optimize the use and reliability of the system.

Important Safety Guidelines for the Model 903W Chlorine Analyzer

Please read the following warnings and cautions carefully before using the 903W Chlorine Analyzer

⚠ WARNING This equipment must be used as specified by the manufacturer or overall safety will be impaired.

⚠ WARNING Access to this equipment should be limited to authorized, trained personnel ONLY.

⚠ WARNING Use of unauthorized parts may impair suitability of the equipment for Class I, Div 2 locations.

⚠ WARNING Observe all warning labels on the analyzer enclosures.

The analog outputs and alarm relay contacts may be powered by a source separate from the one (s) used to power the analyzer system. Disconnecting the main power source may not remove power from the analog output signals.

Any safety recommendations or comments contained herein are suggested guidelines only. Galvanic Applied Sciences Inc. bears no responsibility and assumes no liability for the use and/or implementation of these suggested procedures.

This system, when operating in its normal mode, and/or when it is being serviced, maintained, installed and commissioned contains items which may be hazardous to humans if handled or operated incorrectly or negligently. These items include, but are not limited to:

- High Voltage Electrical Energy
- Toxic and Explosive Gases

The 903W Chlorine Analyzer is designed to be safely operated in a Class 1, Div.2, Group B, C and D,T3 area.

Manufacturer's Warranty Statement

Galvanic Applied Sciences Inc. ("Seller") warrants that its products will be free from defects in materials and workmanship under normal use and service in general process conditions for 12 months from the date of Product start-up or 18 months from the date of shipping from Seller's production facility, whichever comes first (the "Warranty Period"). Products purchased by Seller from a third party for resale to Buyer ("Resale Products") shall carry only the warranty extended by the original manufacturer. Buyer agrees that Seller has no liability for Resale Products beyond making a reasonable commercial effort to arrange for procurement and shipping of the Resale Products. Buyer must give Seller notice of any warranty claim prior to the end of the Warranty Period. Seller shall not be responsible for any defects (including latent defects) which are reported to Seller after the end of the Warranty Period.

THIS WARRANTY AND ITS REMEDIES ARE IN LIEU OF ALL OTHER WARRANTIES OR CONDITIONS EXPRESSED OR IMPLIED, ORAL OR WRITTEN, EITHER IN FACT OR BY OPERATION OF LAW, STATUTORY OR OTHERWISE, INCLUDING BUT NOT LIMITED TO, WARRANTIES OR CONDITIONS OF MERCHANTABILITY AND FITNESS FOR A PARTICULAR PURPOSE, WHICH SELLER SPECIFICALLY DISCLAIMS.

Seller's obligation under this warranty shall not arise until Buyer notifies Seller of the defect. Seller's sole responsibility and Buyer's sole and exclusive remedy under this warranty is, at Seller's option, to replace or repair any defective component part of the product upon receipt of the Product at Seller's production facility, transportation charges prepaid or accept the return of the defective Product and refund the purchase price paid by Buyer for that Product. If requested by Buyer, Seller will use its best efforts to perform warranty services at Buyer's facility, as soon as reasonably practicable after notification by the Buyer of a possible defect provided that Buyer agrees to pay for travel time, mileage from the Seller's facility or travel costs to the airport / train station closest to Buyer's facility plus all other travel fees, hotel expenses and subsistence.

Except in the case of an authorized distributor or seller, authorized in writing by Seller to extend this warranty to the distributor's customers, the warranty herein applies only to the original purchaser from Seller ("Buyer") and may not be assigned, sold, or otherwise transferred to a third party. No warranty is made with respect to used, reconstructed, refurbished, or previously owned Products, which will be so marked on the sales order and will be sold "As Is".

Limitations

These warranties do not cover:

- Consumable items such as lamps.
- Analyzer components which may be damaged by exposure to contamination or fouling from the process fluid due to a process upset, improper sample extraction techniques or improper sample preparation, fluid pressures in excess of the analyzer's maximum rated pressure or fluid temperatures in excess of the analyzer's maximum rated temperature. These include but are not limited to sample filters, pressure regulators, transfer tubing, sample cells, optical components, pumps, measuring electrodes, switching solenoids, pressure sensors or any other sample wetted components.
- Loss, damage, or defects resulting from transportation to Buyer's facility, improper or inadequate maintenance by Buyer, software or interfaces supplied by Buyer, operation

outside the environmental specifications for the instrument, use by unauthorized or untrained personnel or improper site maintenance or preparation.

- Products that have been altered or repaired by individuals other than Seller personnel or its duly authorized representatives, unless the alteration or repair has been performed by an authorized factory trained service technician in accordance with written procedures supplied by Seller.
- Products that have been subject to misuse, neglect, accident, or improper installation.
- The sole and exclusive warranty applicable to software and firmware products provided by Seller for use with a processor internal or external to the Product will be as follows: Seller warrants that such software and firmware will conform to Seller's program manuals or other publicly available documentation made available by Seller current at the time of shipment to Buyer when properly installed on that processor, provided however that Seller does not warrant the operation of the processor or software or firmware will be uninterrupted or error-free.

The warranty herein applies only to Products within the agreed country of original end destination. Products transferred outside the country of original end destination, either by the Seller at the direction of the Buyer or by Buyer's actions subsequent to delivery, may be subject to additional charges prior to warranty repair or replacement of such Products based on the actual location of such Products and Seller's warranty and/or service surcharges for such location(s).

Repaired Products

Repaired products are warranted for 90 days with the above exceptions.

Limitation of Remedy and Liability

IN NO EVENT SHALL SELLER BE LIABLE TO BUYER FOR ANY INDIRECT, CONSEQUENTIAL, INCIDENTAL, SPECIAL OR PUNITIVE DAMAGES, OR FOR ANY LOSS OF USE OR PRODUCTION, OR ANY LOSS OF DATA, PROFITS OR REVENUES, OR ANY CLAIMS RAISED BY CUSTOMERS OF BUYER OR ANY ENVIRONMENTAL DAMAGE OR ANY FINES IMPOSED ON BUYER BY ANY GOVERNMENTAL OR REGULATORY AUTHORITIES, WHETHER SUCH DAMAGES ARE DIRECT OR INDIRECT, AND REGARDLESS OF THE FORM OF ACTION (WHETHER FOR BREACH OF CONTRACT OR WARRANTY OR IN TORT OR STRICT LIABILITY) AND WHETHER ADVISED OF THE POSSIBILITY OF SUCH DAMAGES OR NOT.

Section 1 Chlorine Analyzer

1.1 Overview

The Galvanic Applied Sciences Model 903W Chlorine analyzer is designed to measure Chlorine (Cl_2) in a gaseous stream.

1.2 Principle of Operation

The analyzer relies on the chemical reaction between chlorine gas and a paper sensing tape which is sensitive to chlorine.

When the chlorine sensitive paper tape is exposed to chlorine gas, a pink precipitate is formed on the tape. The rate of the color change of the tape is proportional to the concentration of chlorine gas in the sample.

The analyzer can use two different analysis algorithms to determine the concentration of chlorine in the sample.

Standard Analysis (Peak Detect) - In the standard analysis method, the rate of stain formation on the tape is monitored. The point at which the rate of stain is at a maximum represents the concentration of chlorine in the sample gas.

Timed Analysis. In the timed analysis algorithm the average rate of stain on the tape is calculated over a fixed period of time.

1.3 Features of the Analyzer

The analyzer provides the following capabilities:

- Rapid response
- 5-14 week tape life (dependent on gas concentration), which is up to 2 times greater than that of traditional tape analyzers. Optical tape counter ensures exact spacing of stains and keep track of tape consumption
- Low operation and maintenance costs
- Uninterrupted operation with dual redundant AC and DC power supply
- Ethernet communication and USB port with easy to use Windows™ based PC software
- Enhanced data logging allows for up to ten months of data storage for complete audit trail and trouble shooting and report generation.
- Built-in MODBUS communications / RTU capabilities and a large number of outputs and inputs with sensor auto-calibration on each analysis and dual redundant power supply.

1.4 System Operating Control

The analyzer is controlled by a dedicated data acquisition system which provides supervisory control, performs all calculations and provides the user interface.

The system includes an onboard computer system which provides full screen display of the chlorine concentration, key system control parameters and their status.

A hand held key pad is provided for user interface with the analyzer. Operation of the system with the keypad is described in Section 4. As an alternative, a PC based Graphical User Interface (GUI) which can be used to view and enter information on a remote basis is described in Section 5.

1.5 Contents of this Manual

This manual contains the following information:

- **Section 1:** *Model 903W Chlorine Analyzer* presents introductory information about the system and the mode of operation.
- **Section 2:** *Analyzer Components* describes the design of the major components of the system
- **Section 3:** *Installation* describes unpacking the analyzer, installing it in the facility and interfacing with other devices.
- **Section 4:** *Operating the Analyzer via the Handheld Keypad* describes how the user enters data and views system parameters using the hand help controller module and on board display panel.
- **Section 5:** *The Graphical User Interface* presents a detailed discussion of the various aspects of the application program on the personal computer.
- **Section 6:** *Operating the System* discusses the role of the various tabs of the how the various tabs of the Graphical User Interface are employed
- **Section 7:** *Maintenance* includes a discussion of activities which should be performed on a routine bases to optimize operation
- **Section 8:** *Troubleshooting and Service* presents information that is useful in diagnosing problems with the analyzer and describes how various components are replaced.
- **Section 9:** *Quality Control* includes the test documentation material used to test the analyzer
- **Section 10:** *Wiring* includes diagrams to assist the operator in interfacing auxiliary components such as relays, solenoids, etc. to the controller module.
- **Section 11:** *Specifications* presents the specifications for the analyzer.
- **Section 12:** *Spare Parts* lists a number of items which may be required to maintain operation of the analyzer.
- **Section 13:** *MSDS* contains the Manufacturers Safety Data Sheets for chemical materials items used in the system.

Section 2 Analyzer Components

2.1 Overview

The 903W Chlorine analyzer is an integrated system designed to monitor the concentration of chlorine in a gaseous stream using the method described in Section 1. An overview of the major components of the analyzer is presented in Figure 2-1.

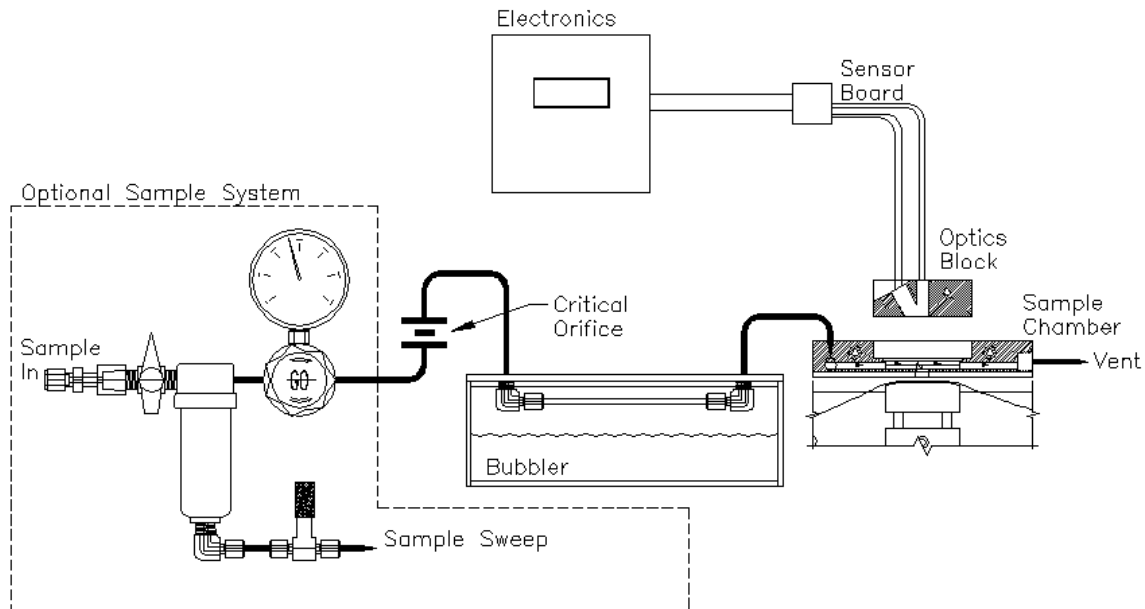

Figure 2-1: Schematic of Flow Path

NOTICE

The chlorine application does not use the bubbler shown in Figure 2-1.

The system includes the following major components:

- Motherboard (Section 2.2)
- Display Board, Keyboard, LED's (Section 2.3)
- Chassis (Section 2.4)
- Tape Transport System (Section 2.5)
- Sample Chamber Assembly (Section 2.6)
- Sample Flow Related Components (Section 2.7)

An external sample conditioning system is available as an option (Section 2.9).

2.2 Motherboard

2.2.1 Description of the Motherboard

The motherboard is housed in an enclosure and consists of a large main board which houses the system memory, system's clock battery, the AC and DC power supplies, 6 isolated analog outputs, 6 relays, 8 solenoids, 4 (Wet contact) discrete inputs and 4 (Dry contact) discrete inputs. The type of enclosure the electronics is housed in will depend on the area classification certification of the analyzer.



Keep any unused screw terminals fully torqued close. Open screw terminals may cause dielectric breakdown in overvoltage conditions.

2.2.2 Boards Associated with the Motherboard

The main processor daughter board and an optional Ethernet card are associated with the motherboard.

2.2.3 AC and DC Power Supply

The motherboard houses the AC and DC power supplies. The working AC voltage range is 100-240 VAC and the DC voltage range is 10-32 VDC.

If an AC supply is used, the analyzer uses the AC solenoid drivers which are Black in colour.

If a DC supply is used, the analyzer uses the DC solenoid drivers which are Red in colour.

The analyzer can operate in a dual redundant power mode in which the DC power supply is the backup if the AC power supply fails. It is important to note that in this mode the DC solenoid drivers would be used.

2.3 LCD Display Board, Keypad and LED's

2.3.1 User Interaction Features

The system presents the system status to the operator via a 128 x 64 LCD display on the front panel. In addition, there are ten LED indicators which provide information about the status of the system.

A hand held keypad is used to communicate with the system. Operation of the system via the keypad is described in Section 4.

A detailed application program for a personal computer is provided to monitor the system, view archived data and establish input and output protocols from/to external devices. A detailed discussion of the user interface is presented in Chapter 5.

2.3.2 Display Board Communication Ports

The system has two distinct communications ports housed on the display board. A USB/RS-232 port is located on the right side of the display board. A pair of switches that can be set for USB or RS232 communications is located on the reverse side of this board on the bottom left hand corner. By default, the switch is set for USB usage.

A RJ-9/22 jack that can also be used for RS232 communications is located directly under the LCD Display. There are jumpers located on the bottom left hand corner of the CPU board that need to be set if this jack is to be used or if the Ethernet card is used. The Ethernet Card option and the RJ-9/22 jack cannot be used simultaneously.

2.4 Inner Swing Panel

The inner swing panel contains all of the mechanical parts of the system including the tape-advance motor, the pulse counter used to accurately advance the tape, the sensing tape spool, and the components related to the actual flow of sample gas and the measurement of the concentration of chlorine in the sample gas stream. A photo of the swing panel is shown in Figure 2-2.



Figure 2-2: Swing Panel

2.5 Tape Transport System

The tape transport system is responsible for advancing the tape and ensuring that the analyzer has a fresh section of white tape available at the commencement of every analysis cycle. The tape transport system is shown in Figure 2-3.



Figure 2-3: Tape Transport System

The tape transport system consists of the supply and take-up reels, the drive motor, the compression head, the pulse counter, and the optional low-tape sensor.

2.5.1 Supply and Take-up Reels

The supply and take-up reels are the key components in the tape transport system.

- The supply reel, which has a small screw-on retaining disk, is found on the bottom of the chassis, and can hold reels of tape up to 350 feet in length. The tape is threaded over the lower tape guide, past the sample chamber assembly and compression head, over the two upper tape guides, and finally over the pulse counter pulley before reaching the take-up reel.
- The take-up reel, which has a large screw-on retaining disk, is driven by the motor, and is responsible for advancing the tape at the end of every cycle.

A small electric motor that is controlled by the main processor of the system turns the take-up reel to advance the tape at the beginning of every analysis cycle to ensure that the next analysis has a section of unreacted reagent to react with the chlorine.

The motor is either installed inside the chassis. The length of time that the motor runs is controlled by the system processor in conjunction with the pulse counter.

2.5.2 Pulse Counter

The pulse counter is used to ensure even spacing of stains on the sensing tape. The pulse counter is shown in Figure 2-4.

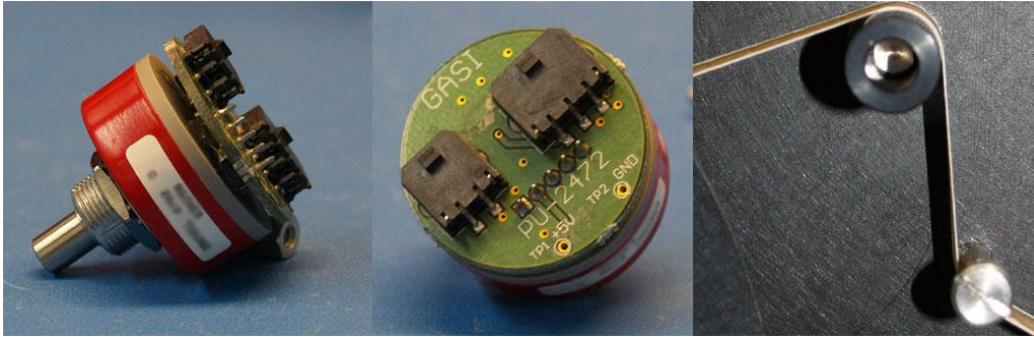

Figure 2-4: Pulse Counter

The left and centre pictures show the pulse counter as it appears when not installed in the chassis and the right picture shows how the pulse counter appears in the tape transport system. The black aluminum (or grey plastic) capstan is mounted on the silver nub seen in the left picture, and it rotates when the tape moves over it.

The pulse counter produces a specific amount of pulses for every revolution. By measuring the number of pulses produced by the movement of the tape while the motor is running, the system processor can ensure that the tape is advanced exactly the same distance before every analysis cycle, regardless of the quantity of tape on the take-up reel. This ensures that the stain spacing on the tape is even; further, by reducing the amount of white space between subsequent stains, tape wastage is minimized, and tape life is maximized.

When the motor advances the take-up reel, causing the tape to move, the movement of the tape causes the capstan on the pulse-counter to rotate, producing pulses. These pulses are read by the sensor block, which then sends the pulse count to the system processor. When the processor receives a number of pulses equal to the number of pulses per advance set in the application program; typically around 40 pulses, or a little less than one sixth of a revolution, it sends a signal to the motor to stop turning, and the tape stops advancing.

The pulse counter also allows the system to accurately indicate the quantity of tape remaining on the supply reel, as long as the initial length is set correctly in the application program or through the keypad. This value is displayed on the LCD in the upper right corner, and can be output through an analog output. The quantity of tape remaining is calculated after every analysis cycle, using the formula outlined in Section 5.9.1.1. This value can also be used to trigger a low-tape alarm when the quantity of tape goes below a user-set value, set up through the application program.

2.6 Sample Chamber Assembly

The sample chamber assembly is the key component in the measurement of the chlorine concentration in the gas. The sample chamber assembly allows the sample gas to pass onto the sensing tape, and also contains the detector assembly, (sensor block). An exploded view of the sample chamber assembly is shown in Figure 2-5.

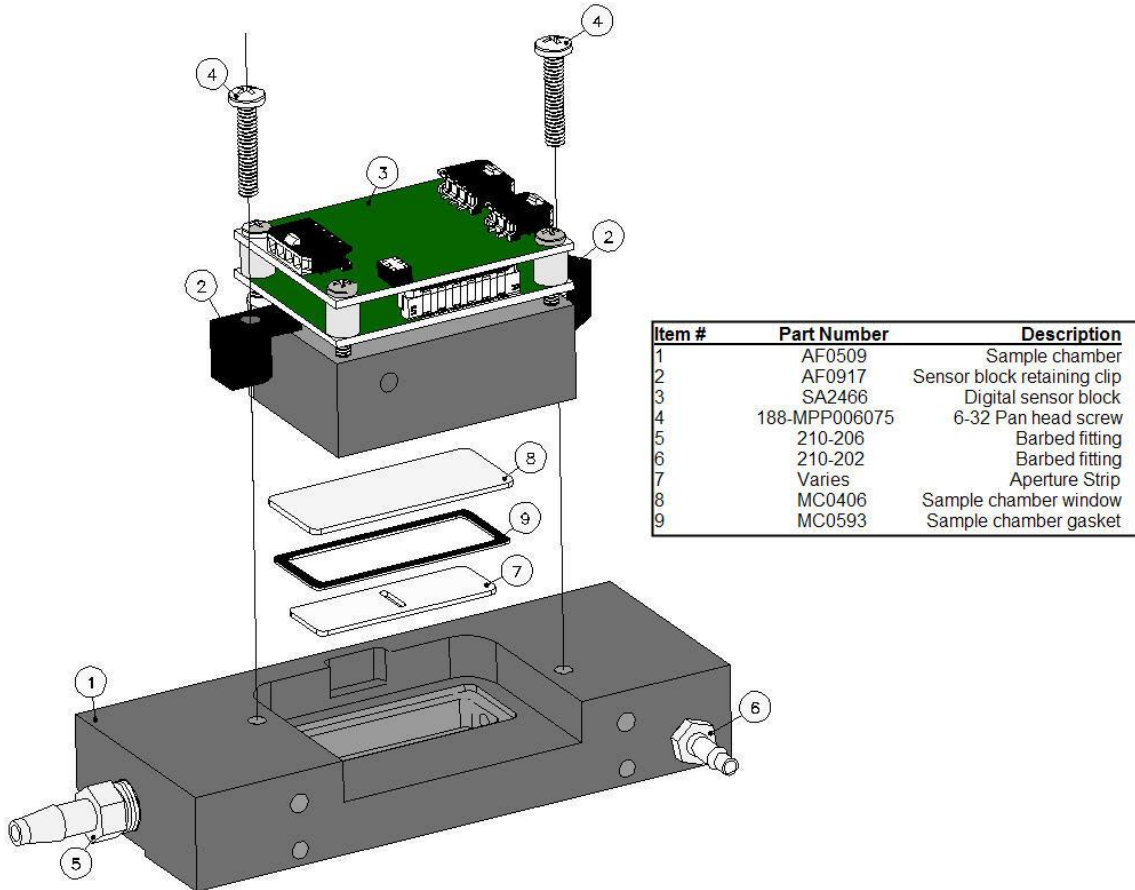

Figure 2-5: Sample Chamber Assembly (Exploded View)

2.6.1 Rate/Read Aperture Strip and the Rear Window Assembly

The Rate/Read Aperture strip and the Rear Window are made of a clear plastic to allow the light from the sensor block to pass through to the tape to correctly measure the rate of color change on the tape. The sensor block is held onto the sample chamber via clips; by tightening the screws on the clips, the rear window is pressed into the rear window rubber gasket and sealed to the sample chamber by pressure from the sensor block above it. The rate/read aperture strip is sealed to the inside of the sample chamber using silicone grease. The sample flow through the sample chamber assembly is shown in Figure 2-6.

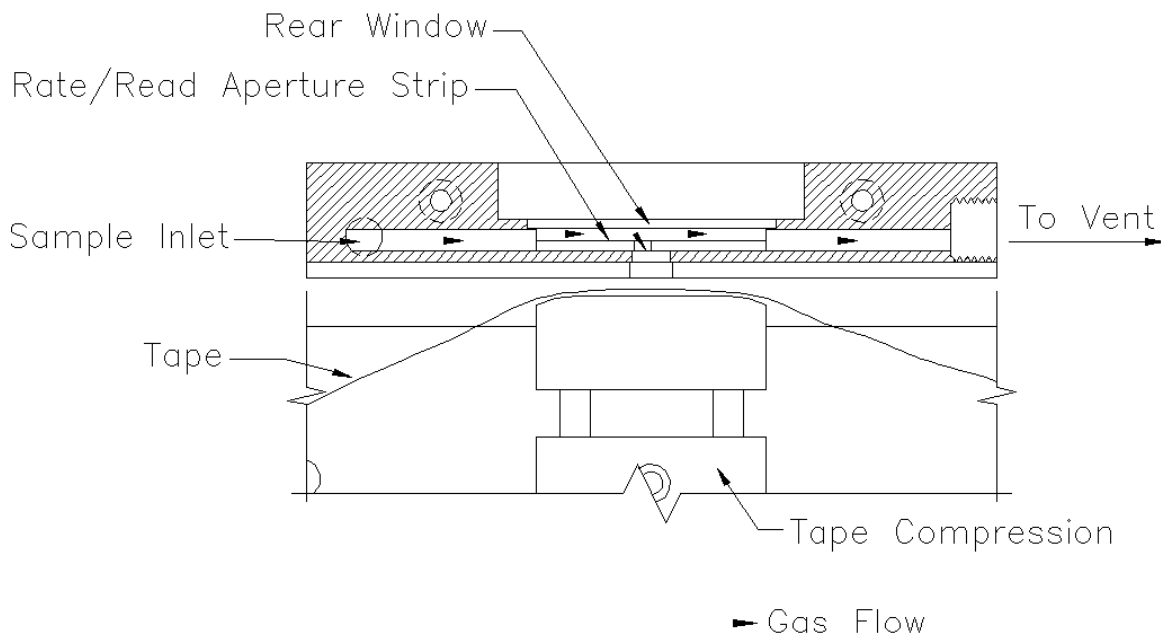

Figure 2-6: Sample Flow

Clean, humidified, and flow-regulated sample enters the sample chamber from the sample inlet and passes over the Rate/Read Aperture strip, behind the rear window. Some of the gas passes through the aperture strip and onto the sensing tape, causing a measurable color change. The tape is held firmly against the sample chamber by the compression head. The amount of gas that passes onto the tape is dependent on the size of the aperture strip. After the gas passes over the tape, it is vented.

2.6.2 Read/Rate Aperture Strip

The Read/Rate aperture strip is used to control the quantity of gas that is actually passes onto the sensing tape. If the chlorine concentration in the sample gas is high, it may be necessary to reduce the quantity of gas that passes onto the tape to react with the reagent on the tape, otherwise the rate of color change will be too fast for the system to correctly analyze the sample and poor results will be obtained. Likewise, if the chlorine concentration in the sample gas is low, it is necessary to allow more sample gas to pass onto the tape to allow the rate of colour change to be high enough to produce reliable results. The size of the aperture in the read/rate aperture strip is small for high concentrations, and for low concentrations it is large. Certain ranges do not even require an aperture strip.

Galvanic Applied Sciences provides a broad range of read/rate aperture strip sizes. The most common aperture strip sizes are listed in Table 2-1 along with the maximum ranges they are capable of measuring and their correct part numbers. For other ranges, please contact Galvanic Applied Sciences.

Table 2-1: Read/Rate Aperture Strip Sizes and Associated Ranges

Maximum Range (ppm)	Aperture Strip Size	Part Number
<300 ppb	Wedge	MC1136
>300 ppb	Wide Open	N/A

The range for each read/rate aperture strip size is the range between the maximum range of the next largest aperture strip size and the maximum range of the given aperture strip size. In addition, the system is capable of measuring ranges outside those listed in this table; please contact Galvanic Applied Sciences for more details.

2.6.3 Sensor Block

The Sensor Block consists of two electronics boards, a microprocessor board, and a colorimetric detector. The sensor block is shown in Figure 2-7.

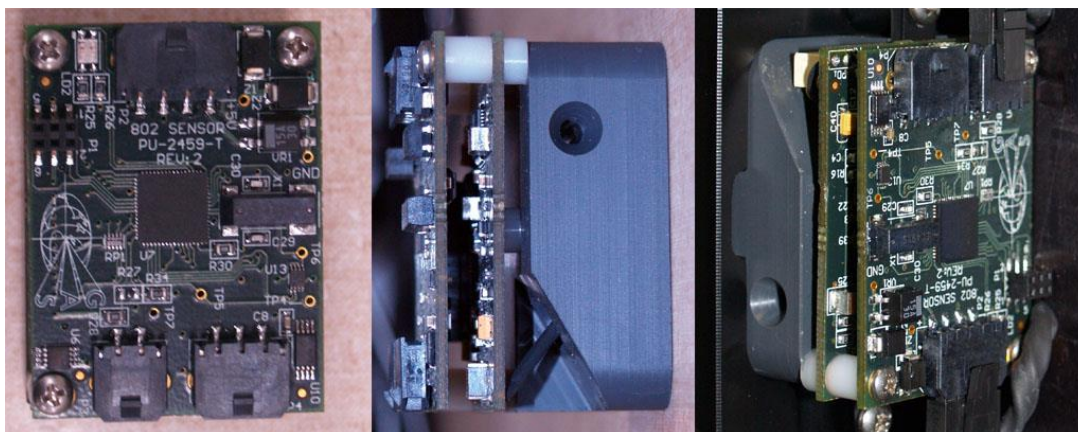

Figure 2-7: Sensor Block (From Left: Top View, Side View, and Installed View)

The sensor block measures the intensity of light reflected off of the sensing tape. The light emitting diode emits a beam of green light that passes through the rear window and the rate/read aperture strip and is reflected off of the sensing tape. The reflected light then passes back through the aperture strip and rear window to reach the photodiode detector, where it is measured. As the stain on the tape gets darker and darker while exposed to chlorine, the amount of light reflected back to the photodiode detector is reduced. The change in the amount of light reflected back to the photodiode detector is directly proportional to the concentration of chlorine in the sample gas.

The sensor block communicates with the electronics assembly via an RS-485 connection. If the connection between the sensor block and the electronics assembly is broken for any reason, a Sensor Communication Alarm will be triggered and the analyzer is considered to be in a Fail State.

The sensor block contains a temperature sensor that measures the ambient temperature near the sensor block. This temperature sensor can be used to trigger alarms should the ambient temperature rise above or drop below set amounts, values that can be set in the GUI.

The sensor block plays a key role in the tape advance algorithm. While the tape advance motor is running, the sensor block receives pulses from the pulse counter. When the sensor block receives the number of pulses set in the GUI it sends a message to the system's main processor. The processor then sends a message to the motor to stop advancing the tape.

2.6.4 Compression Head

The compression head is the component in the tape transport system that seals the sensing tape up against the sample chamber. The compression head is shown in Figure 2-8.

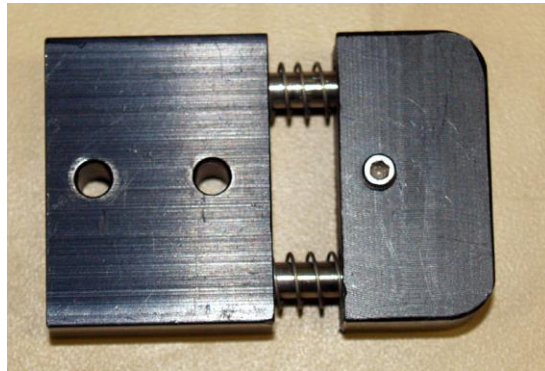

Figure 2-8: Compression Head. Actual installed part may not be exact.

The compression head is comprised of anodized aluminum alloy held up against the tape and sample chamber by means of two springs. The smoothed aluminum construction ensures that the tape moves smoothly past the compression head, preventing tape breakage.

The compression head creates a seal between the tape and the sample chamber and it ensures that the stains on the tape are even and have sharp edges, which produces much better results. In addition, because the anodized surface is black, it prevents stray light from being detected by the photodiode on the sensor block. This in turn prevents inadvertent

triggering of high concentration alarms, as stray light could make the system report that it was analyzing a much higher concentration gas than it actually is.

2.7 Sample Flow Related Components

The system contains a number of components that control the flow of the sample and condition it

It is essential to have a consistent flow rate because the concentration reading is dependent on sample flow rate. The higher the flow rate, the more sample gas comes into contact with the sensing tape in a given period time, and thus the faster reaction and higher concentration reading.

2.7.1 Rotameter

The rotameter is a device that controls and indicates the flow rate through the system. It is mounted on the right side of the 903W enclosure.

2.7.2 Power Vent (Eductor)

The power vent (eductor) produces a positive pressure at the exhaust while allowing the analyzer vent to remain at ambient pressure. An eductor is shown in Figure 2-1.

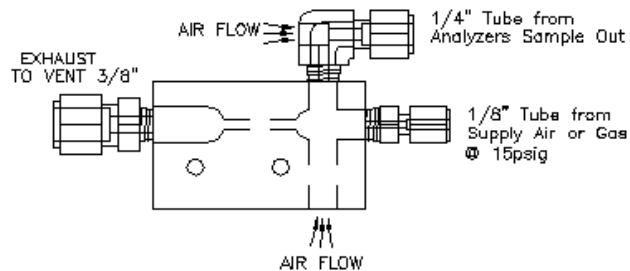

Figure 2-10: Eductor

The eductor has two purposes:

- Changes in ambient pressure can affect the results produced by the system. If the system is inside a building where there is a fluctuating static pressure in comparison to the outside ambient pressure, the power vent will eliminate any influence on the tape staining.

Static pressure changes inside the building are normally caused by building vent fans coming on and off which will change the differential pressure across the sample chamber. Pressure can also be affected by a strong wind blowing across the vent. When this happens, a slight change in the pressure of the sample between the tape and the sample chamber occurs.

The slight change in differential pressure across the tape can cause a reduction in the seal between the tape and the sample chamber, resulting in poorly shaped stains that give poor

results. It can also cause more air to be introduced into the sample chamber, diluting the sample gas and producing lower-than-expected results.

- If the system is located in a cold climate, the humidified sample gas passing out of the vent can freeze, blocking off the flow through the sample system. By using a power vent, the residence time of the sample gas within the system is reduced, making it less likely that the moist air will freeze inside the analyzer.

2.8 Sample Conditioning System (Optional)

The sample conditioning system is an optional accessory that filters the sample gas and lowers it to a pressure suitable for use in the system. A typical sample conditioning system is seen in Figure 2-14.

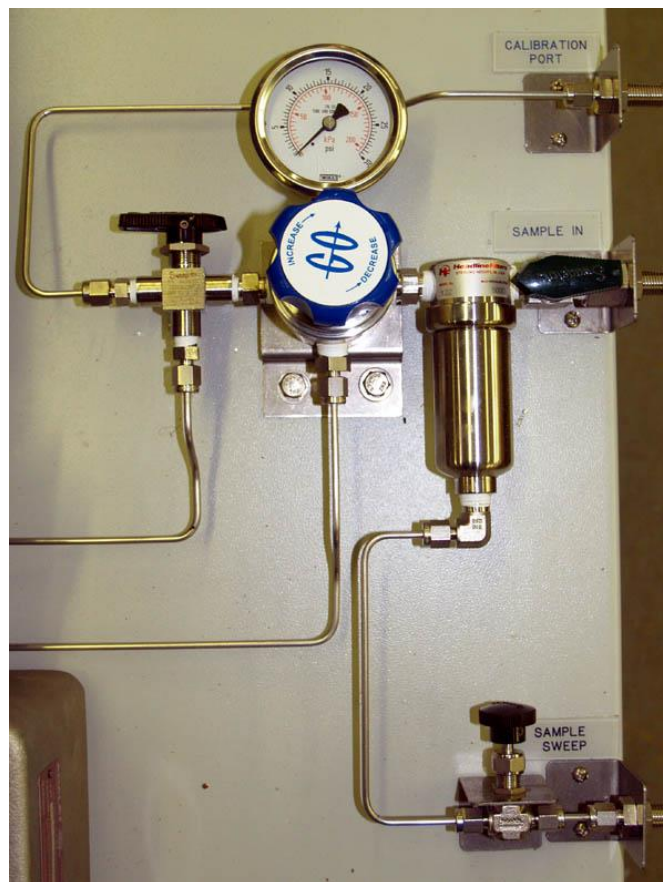

Figure 2-14: Typical Sample Conditioning System

The sample conditioning system generally consists of a filter, a pressure regulator to regulate the sample down to 15 psig, and a valve to switch between calibration and sample gas to allow the system to be calibrated.

The type of filter is dependent on the nature of the gas and generally has a sample sweep associated with it. Sample gas is usually taken off the bottom of the regulator to drive the

power vent. The calibration valve can be either a manual 2-way valve or a solenoid controlled by the system.

Section 3 Installation

3.1 Receiving the System

When the system arrives, inspect the packaging for external signs of damage. If there is any obvious physical damage, contact the shipping agent and Galvanic Applied Sciences to report the damage and request that the carrier's agent be present when the unit is unpacked. It is recommended that you retain the shipping container so that it may be used for future shipment of the unit, if necessary.

3.2 Installation Requirements

3.2.1 Electrical Requirements

Supply Voltage		
Voltage (Volts)	Frequency (Hz)	Power (Watts)
10-32 DC	NA	25 watts maximum
90-120 AC	50/60	150 watts maximum
220-240 AC	50/60	150 watts maximum

The power requirement for solely the electronics is approximately 10 W. Additional power is required depending on the number and type of solenoids installed. When choosing a primary power source, the type of solenoid drivers needs to be considered (AC or DC).

If desired, it is possible to connect both AC and DC power supplies. In this manner, the DC power supply acts as a backup power.

3.2.2 Location of the System

The system is designed to be operated at ambient temperatures from 10 - 50°C. Galvanic Applied Sciences offers complete analyzer shelters from sun shades to complete buildings, please contact Galvanic Applied Sciences, Inc. (or your local representative) for additional information.

The system should be mounted in a location where it is not exposed to excessive vibration. In addition, it should be mounted in a location where the ambient pressure remains relatively consistent over the course of a day

The vent line cannot have any backpressure on it, as backpressure can seriously impact readings. The vent line should be as short as possible at a slight continuous downward slope.

3.2.3 Space Requirements

The size of the analyzer is 17" H x 19" W x 9" D (43 cm x 48 cm x 23 cm). Mounting information is provided in Figure 3-1.

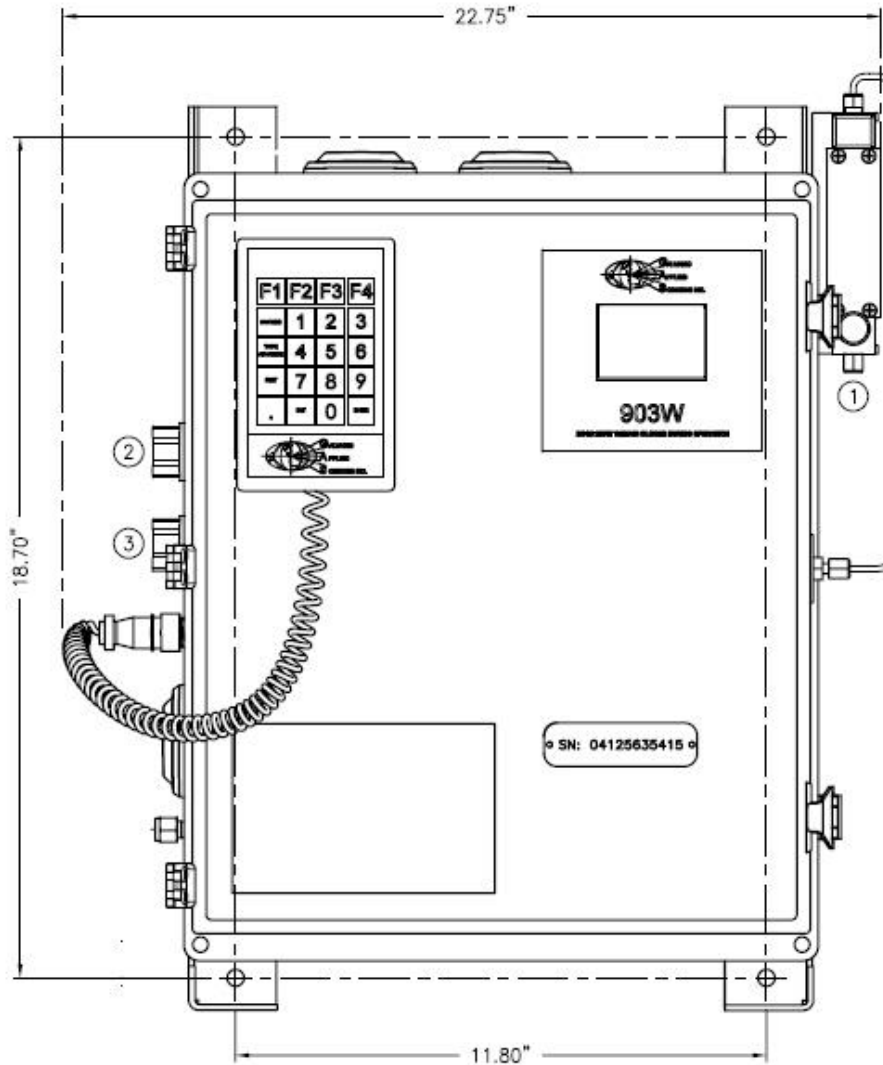

Figure 3-1: Analyzer Dimensions

If the system is mounted on a panel, allow approximately 15" clearance on the left hand side of to allow the removal of the tape cover on the side of the chassis, and to allow easy access for tape installation and removal.

If the system is installed in a cabinet, allow 6" clearance on the left hand side for the installation of a vent line.

The optional sample conditioning system is typically mounted on the sample panel to the right of the analyzer.

3.2.4 Area Classification Information

Class 1, Division 2, Groups B, C & D, T3

3.2.5 Gas Requirements

If the analyzer is not provided with a sample conditioning system, the sample gas needs to be clean and regulated at 15-20 psig.

3.2.6 External Power Switch

The ProTech903W is designed to be installed at a measurement site on a permanent basis and is permanently connected to the main power supply. A suitably located and easily reached switch must be included in the installation. The switch must be marked as the disconnecting device for the analyzer. The switch must have clearly marked ON and OFF positions. No power consuming components shall be located electrically between the power source and the disconnecting device. See Section 3.2.1 for the power requirements of the analyzer.

3.3 Unpacking

To unpack the system:

- a) Open the shipping container and remove all packing material and boxes. Visually inspect the system and accessories package(s) to ensure that no damage has occurred. If damage has occurred, save all packing material and contact the shipping company as well as Galvanic Applied Sciences.

If any damage is visible, do **not** proceed with the system installation. Do not attempt to facilitate repairs yourself as this will negate and/or invalidate any possible insurance claims or equipment warranty.

- b) Place the small packages aside in a safe, secure storage area as they are not needed at this stage of the system installation.

3.4 Installation of the Software

3.4.1 Computer Requirements

Table 3-1 shows the computer requirements for the application software.

Table 3-1: Computer Requirements for Application Software

Parameter	Requirement
Operating System	Microsoft® Windows™ 2000, XP, Vista or Windows 7
Memory	Minimum 512MB
Disk Drives	A CD ROM drive is required to read the installation disk, and a minimum of 20 MB of space is required for installation on the PC hard drive. Additional space is required to save analyzer configurations and archive data.
Serial/USB Port	The analyzer can be connected to the PC via either a 9-pin male serial connector or via a standard USB cable (included with the analyzer). The COM port used to connect to the system cannot be used for any other purposes; otherwise connecting to the system will not be possible.
Display	Minimum required resolution is 1024 x 768.

3.4.2 Install the Application Software

The application program that is included with the analyzer allows the operator to perform analyses and configure all aspects of the analyzer's operation. The application program is capable of communicating with the analyzer through USB, RS-232 (serial), or High Speed LAN (Arcnet) and allows the user to set up MODBUS communications.

To install the application software:

- a) Insert the compact disk that was included with the system into the CD ROM drive of the personal computer. A window will be presented showing the contents of the CD (Figure 3-3).

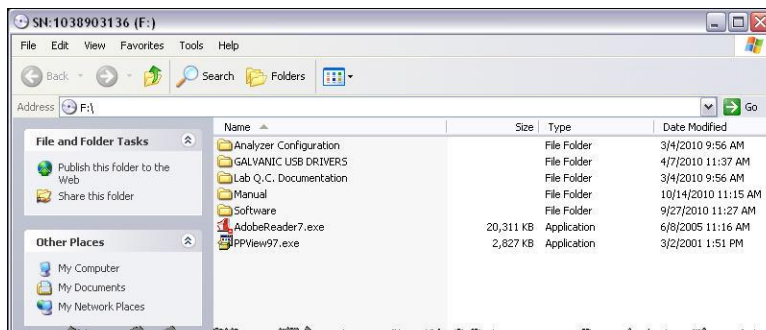

Figure 3-3: CD Contents

The application software is located in the *Software* folder. It is not necessary to transfer the contents of the CD to your computer as the application program will install itself in a designated folder on the hard drive. Open the folder and double click on the executable file (GAS903W_vxxx_date.exe) to install the program. xxx is the version number and the date of generation the file will be indicated (e.g. GAS903W_v100_Aug.15, 2011a indicates version 100a, generated on August 15, 2011). If you have any questions about the software, please include the version number.

3.4.3 Power up the Analyzer

When the analyzer is powered up, it will go through a number of diagnostic protocols and display the results on the front panel display. After about 1 minute, the main screen will be presented (Figure 3-4).



Figure 3-4: The Main Analyzer Screen

- a) Open the *Galvanic USB Drivers* folder on the computer and the *QS Driver download* subfolder then double click on the *QS Driver Installer* to install the drivers. Follow the on screen instructions.

NOTICE

If you are not using the USB mode of communication between the analyzer and the computer, skip step b and continue to Section 3.4.3.

- b) Connect the *USB to USB* cable that is provided with the system to the analyzer and the personal computer. The Message *Found New Hardware* should be presented and the driver installation will be completed automatically.

NOTICE

If this message is not presented, then reboot the computer. The analyzer will then be recognized.

3.4.4 Connect the System to the PC via RS-232

NOTICE

By default, the system is configured at the factory for communication via the USB mode. If the USB mode of communication is desired, skip the rest of this section and proceed to Section 3.4.4.

If the PC is not configured with a USB port, connect the USB end of the USB-Serial cable included with the analyzer to the USB port to the right of the LCD display on the front of the analyzer (between the labels Rx USB and Tx USB) and connect the serial end of this cable to the male 9-pin serial port on the PC.

If you choose to use RS-232 communication, it will be necessary to change the position of a pair of dipswitches located on bottom left hand corner on the back of the display board (Figure 3-5). It is necessary to open the 903 electronics enclosure to access this dipswitch.

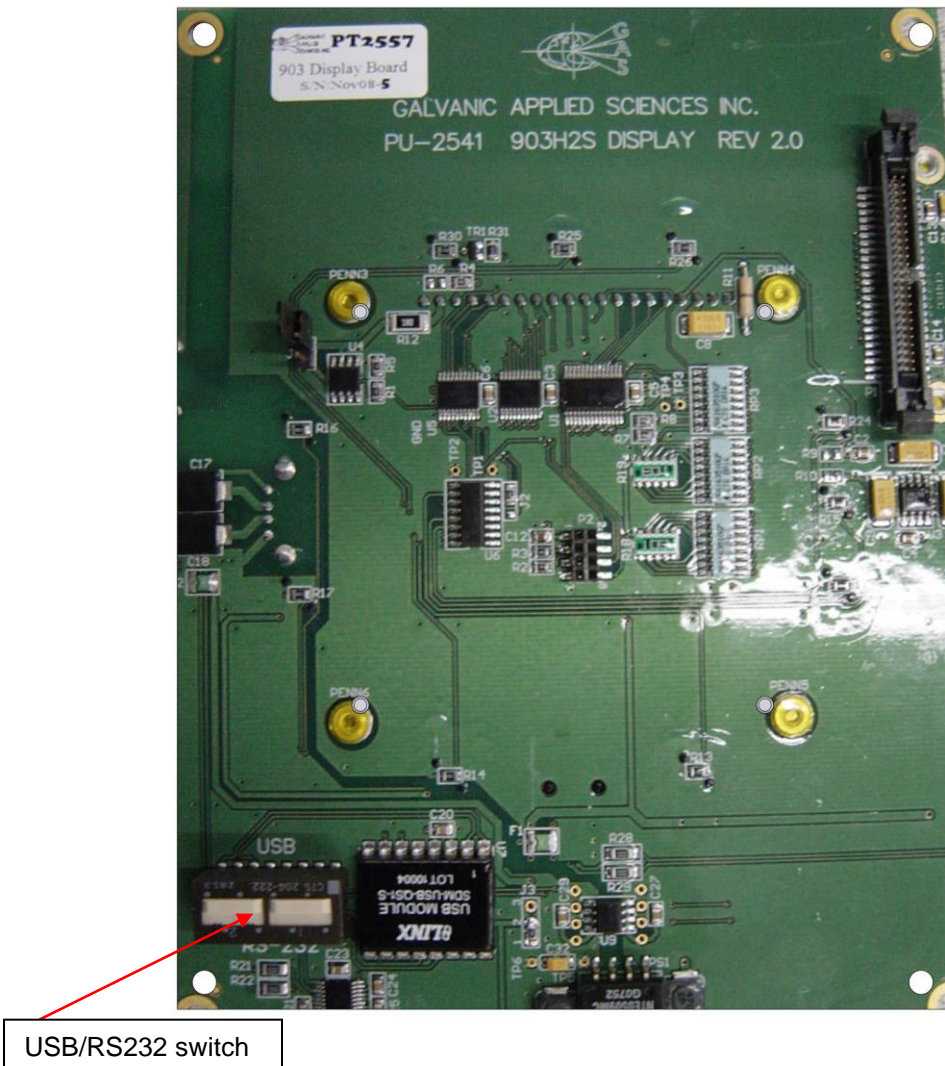

Figure 3-5: Display Board

If both switches are in the **Up** position (marked on the display board as **USB**), the analyzer will communicate via USB. If both switches are in the **Down** position (marked on the electronics board as RS-232), the analyzer will communicate via RS-232.

3.4.5 Open the Application Program and Set Communication Parameters

To open the application program, double click the *GAS903* icon on the desktop (Figure 3-6).



Figure 3-6: GAS903 Software Icon

Click on the *Communications Settings* button (Figure 3-7) on the button bar of the application program to access the *Communications Setup* dialog box window (Figure 3-8).



Figure 3-7: Communication Settings Button

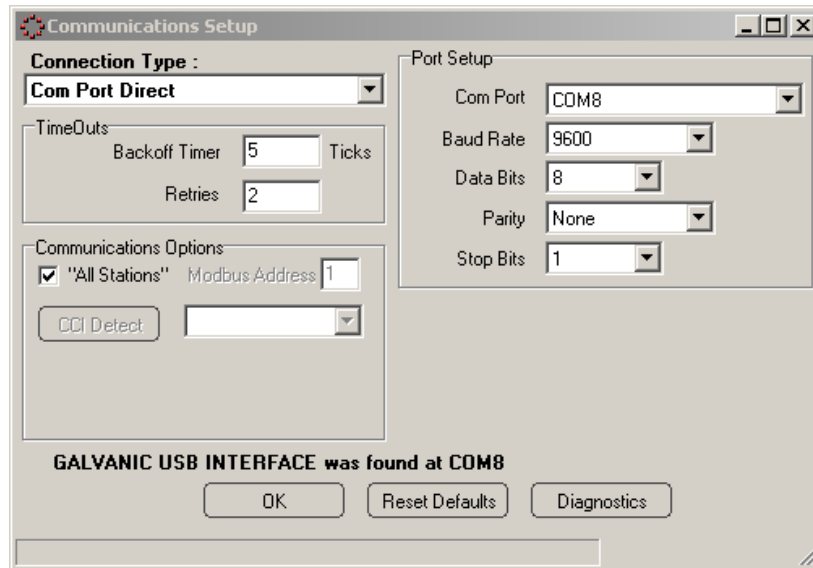

Figure 3-8: Communications Setup Dialog Box (Com Port Direct)

The communications program allows the user to choose from four types of protocols, Com Port Direct (Section 3.4.4.1), Modem (Section 3.4.4.2), Dial-up Networking (RAS) (Section 3.4.4.3) and Ethernet (TCP) (Section 3.4.4.3).

3.4.5.1 Com Port Direct Option

Com Port Direct (Figure 3-8) is set as the default communication type. The program will automatically detect the com ports that are available. The desired com port can be selected from the drop-down menu. If RS-232 or USB is used, the baud rate should be set at 9600. For analyzers shipped after March 2012 or with a firmware revision of 02.04.05 or higher, the default GUI serial port baud rate is 57600 bps.

3.4.5.2 Modem Option

If the *Modem* option is selected, the *Communications Setup* dialog box will appear as in Figure 3-8: Communications Setup Dialog Box

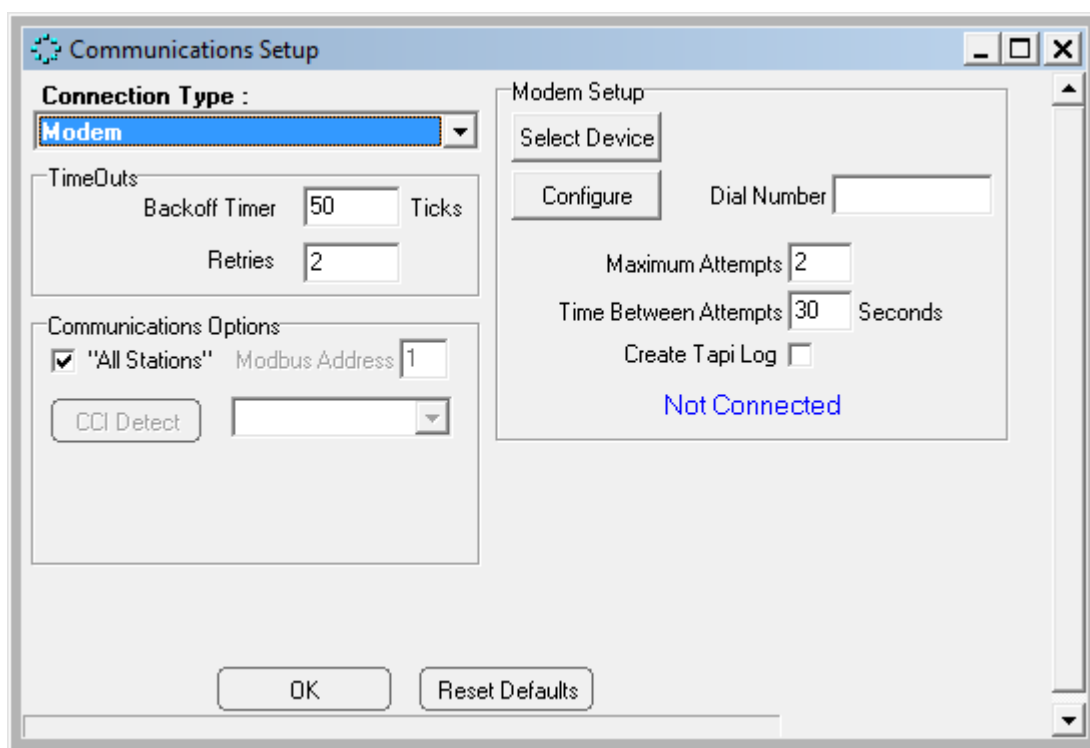

Figure 3-9 Communications Setup Window (Modem)

Enter the number to be dialed by the modem (if a "9" is required to access an outside line, or a "1" is required to communicate with a computer that is outside the immediate telephone calling area, make certain that the appropriate numbers are included (e.g.914035551212).

The *Timeouts* field provides two options - *Backoff Timer* and *Retries*. The *Backoff* timer tells the application program how much time, in ticks (one tick = 55 milliseconds), to wait for a response from the analyzer before retrying to contact the analyzer. If the communication link between the analyzer and the computer is slow or unreliable, perhaps because of a long distance between the computer and the analyzer it may be necessary to increase these

numbers to allow for a successful communications link. Leave all other configuration parameters at their default settings.

3.4.5.3 Ethernet Option

If the *Ethernet* option is selected for the connection type, the *Communications Setup* dialog box window will appear as in Figure 3-8: Communications Setup Dialog Box

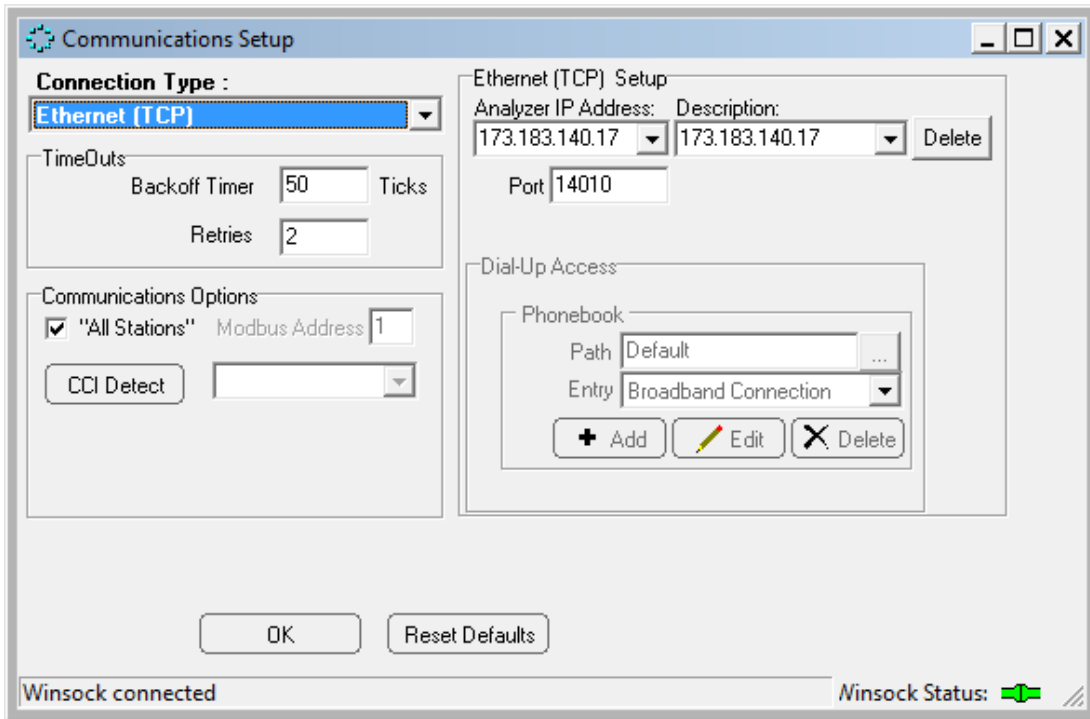

Figure 3-10: Communications Setup Window (Ethernet (TCP))

The user can set-up a list of IP addresses along with a description for each in the *Analyzer IP Address* region of the *Ethernet (TCP) Setups* field.

The *Communications Options* field is used to set the *Modbus Address* field to the desired Modbus address (valid range from 1 to 255). As an alternative, put a checkmark in the *All Stations* checkbox, which will cause the analyzer to poll all possible Modbus addresses.

The *Timeouts* field provides two options - *Backoff Timer* and *Retries*. The *Backoff* timer tells the application program how much time, in ticks (one tick = 55 milliseconds), to wait for a response from the analyzer before retrying to contact the analyzer. If the communication link between the analyzer and the computer is slow or unreliable, perhaps because of a long distance between the computer and the analyzer it may be necessary to increase these numbers to allow for a successful communications link. Leave all other configuration parameters at their default settings.

3.4.5.4 Connect the Computer and the Analyzer

Once the settings are correctly set, press the *OK* button to close the *Communications Setup* dialog box and press the *Logon* button (Figure 3-11) on the button bar to connect the computer to the analyzer.



Figure 3-11 Logon Button

After the *Logon* button is pressed, an information line with increasing length will appear on the screen. When the logon process is complete, the GUI will present a dialog box (Figure 3-12) asking if the operator wants to enter *Read-Only* or *Update* mode.

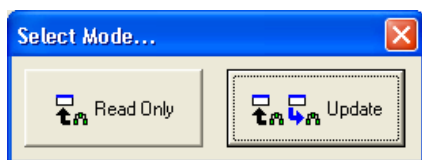

Figure 3-12: Select Mode Dialog Box

Read Only mode does not allow the operator to write any changes to the analyzer. It allows the operator to view all aspects of the application program and review all the settings of the analyzer, but prevents the operator from writing any changes to these settings.

Update mode allows the operator to make changes to settings in the application program and write these changes to the analyzer. This mode is password protected to prevent unauthorized changes to the analyzer. The password for the *Update* Mode is set by default to 2222 and can be changed as described in Section 5.2.1

If the operator has logged into the analyzer in *Read Only* mode, it is possible to enter *Update* mode by going to the *Tools* menu and selecting *Update* to present the *Password Request* dialog box. If the correct password is entered, the application program will then be in *Update* mode.

If communication is unsuccessful, ensure that:

- a) the correct COM port is chosen
- b) the correct baud rate is chosen
- c) the cable is securely connected to both the PC and the analyzer.
- d) the IP address is correct

If changing the baud rate and COM port or the IP address still does not result in a successful connection, please call Galvanic Applied Sciences' technical support.

3.5 Installing the Keypad and Sensing Tape

3.5.1 Installing the Keypad

Connect the keypad to the military connector on the left side of the chassis

3.5.2 Installing the Sensing Tape

The sensing tape is installed in the tape enclosure. Figure 3-13 presents shows a photo of the tape enclosure with all components numbered.

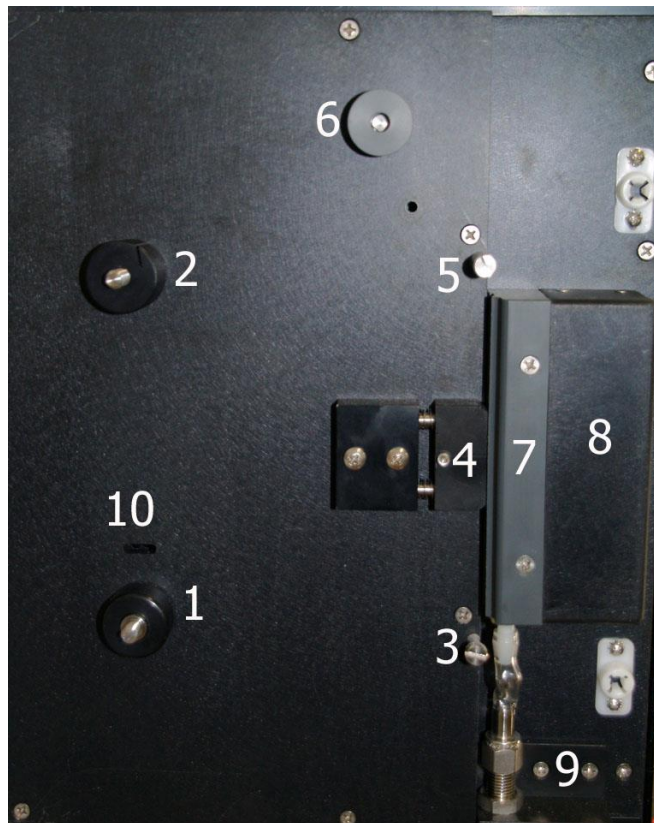

Figure 3-13: Tape Enclosure (see text for reference numbers)

To install the tape:

- a) Remove the tape cover from the left side of the chassis.
- b) Remove the screw-on retaining disks (not shown) from the supply reel (1) and take-up reel (2).
- c) Take a new reel of tape and remove the adhesive tape securing the end. Place the tape reel on the supply reel. Make sure the tape is installed so that the loose end hangs down on the left side of the reel, not the right or observe the "This Side Out" stamp on the side of the tape.
- d) Thread the tape over the lower sample chamber guide pin (3). Push the compression head (4) back and slide the tape behind the compression head. Ensure that the tape is flat against the groove in the sample chamber (8) and has no creases.
- e) Pull the tape up over the upper sample chamber guide pin (5).
- f) Thread the tape over the black aluminium / grey plastic capstan of the pulse counter (6). (Note that this capstan may be either aluminium or plastic).
- g) Fold over the first inch of the tape, and then slide this folded end of the tape into the slot on the take-up reel (2), as shown in Figure 3-14.



Figure 3-14: Insertion of Tape End into Take-up Reel

- h) Replace the screw-on disks onto the supply and take-up reel. The larger disk goes on the take-up reel.
- i) Take up any slack in the tape by rotating the tape reel on the supply reel clockwise until the tape is tight.

Figure 3-15 shows the correct installation of the tape on the system. The image on the left shows the completed tape installation without the retaining disks and the one on the right shows the tape installation with the disks.

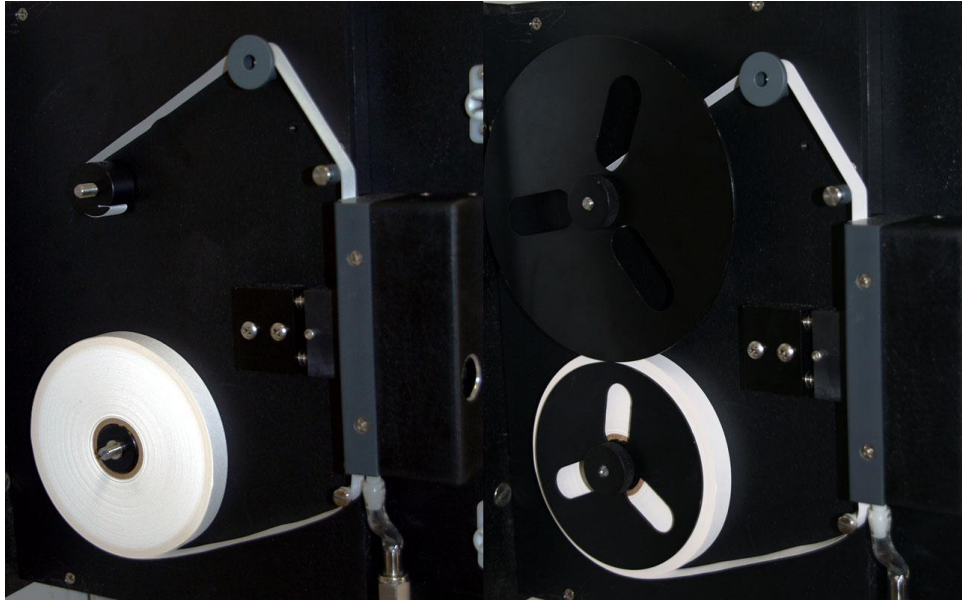

Figure 3-15: Installation of Sensing Tape

Using the keypad, press *F4*, and then press *F1* to access the *Config-Gen* screen. The top line refers to the Tape Length. Press *Edit*, indicate the tape length (300 foot reels of tape are included in the shipment with the analyzer) and press *Enter*.

3.6 Connecting Gas to Analyzer

3.6.1 Connecting Gas to the Analyzer

To connect gas to the system:

- a) Attach sample gas lines to the sample inlet, zero gas, calibration gas and reference gas ports on the analyzer.
- b) If the analyzer is equipped with a sample system, set the pressure regulator to 15 psig. If the analyzer is not equipped with a sample system, ensure that the sample gas is clean and is regulated to a pressure of 15 psig before connecting it to the system.

3.6.2 Leak Testing of the Compression Head

To ensure that repeatable data is obtained, it is essential to have a good seal between the compression head, the tape, and the sample chamber. To test the seal, Galvanic recommends the use of a Dwyer Minihelic II gauge, available from Galvanic Applied Sciences. The gauge measures a range of pressure from 0 to 5 inches of water column.

The following procedure is used to leak-check the analysis compression head and to ensure that a proper seal is obtained:

- a) Make sure the flow indicated on the chassis rotameter is approximately 2.0 before following this procedure.
- b) Place the system in *Bypass* mode via the hand held keypad before carrying out this procedure.
- c) Remove the vent line from the elbow at the base of the chassis and attach the Minihelic to the elbow, as shown in Figure 3-21.



Figure 3-21: Minihelic Indicating a Good Seal (L); Connected to Vent Elbow (R)

- d) Check the pressure indicated on the gauge. If the pressure reads 4 or above, as shown in Figure 3-21, the tape is well sealed against the sample chamber by the compression head. Press *Tape Advance* on the keypad and ensure that the pressure does not drop below 3 even when the tape is moving. It should return to 4 by the time the tape stops moving.

If the pressure is NOT 4 or greater, there is a problem with the seal somewhere in the chassis.

3.6.3 Connecting the Power Eductor

The power eductor (see Section 2.7.4) is normally driven by the sample stream through the sample regulator set at 15 psig. Instrument air or plant nitrogen could also be used.

3.7 Testing the Analyzer

Allow the analyzer to run on sample gas for approximately 1 hour. After 1 hour, inspect the stains on the tape and compare them to those in Figure 3-23. If the stains are crisp and well spaced, the compression head is sealing the tape well against the sample chamber. If the stains have fuzzy edges, check the seal again. In addition, check to ensure that the tape is flat against the sample chamber (i.e. not creased) and is correctly installed.

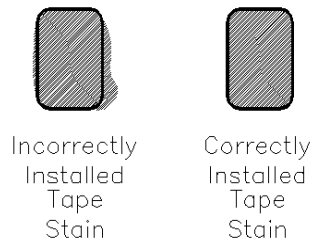

Figure 3-23: Stain Appearance

Once the correct seal has been established, connect a calibration gas of known concentration to the calibration port and perform a manual reference run. Repeat this step for the second stream, if applicable. If the reading on the analyzer LCD screen is within $\pm 2\%$ of the certificate value for the calibration gas, the analyzer is within calibration and can be immediately entered into service.

Once the system is calibrated, it is ready to start analyzing sample gas.

See Section 6.6 if the analyzer requires calibration.

NOTICE

It is recommended that the output signals from the analyzer be validated. Refer to the As Built Mechanical and Wiring Diagrams provided in the analyzer documentation package for location and descriptions of the outputs.

NOTICE

If the system is not calibrated correctly, see Section 5.9.3 for analyzer calibration procedures.

4.1 Introduction

The front panel of the analyzer includes a series of LEDs and a LCD display which provides information about the status of the spectrophotometer. In addition, a hand held keypad is used to view/edit a variety of analyzer settings and analytical results. A comprehensive application program using a personal computer is employed to allow the operator to control all parameters via a personal computer is provided as discussed in Section 5.

The overall operation of the analyzer is controlled by the parameters that are resident in the analyzer. When parameters are established via the application program, it will be necessary to download them to the analyzer (Section 5.3). Similarly, data stored in the analyzer can be transferred to the computer, where they can be archived, plotted and exported as desired.

4.2 The Front Panel LED's

There are nine coloured LEDs on the front panel of the analyzer (Figure 4-1) which indicate specific status and communications related parameters. The functions of the 9 LEDs are provided in Table 4-1.

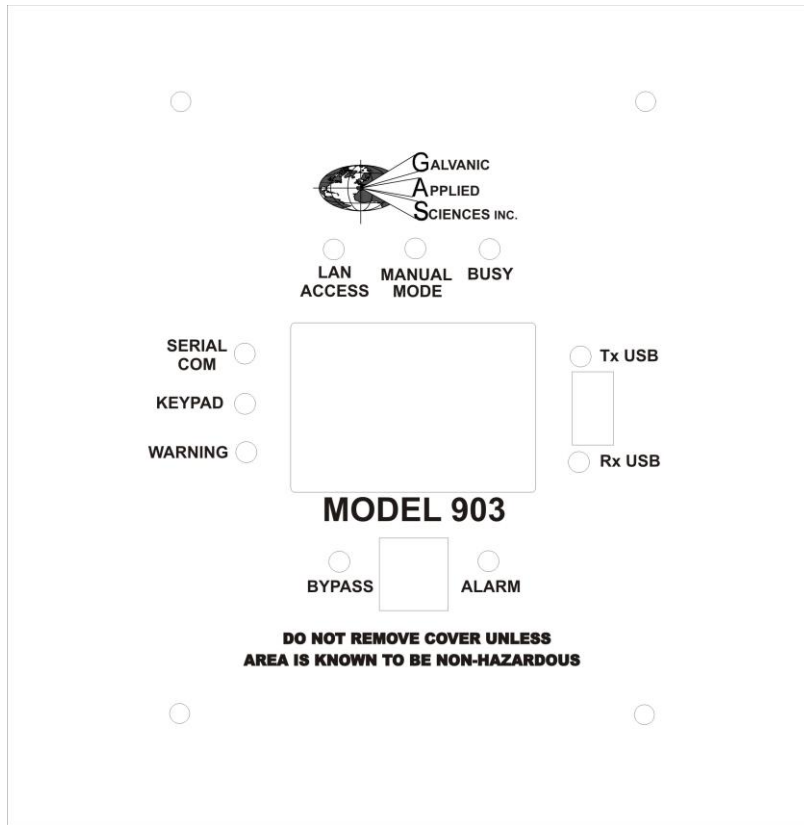

Figure 4-1: Front Panel of the Analyzer

Table 4-1: Front Panel LED Functions

LED Label	Colour	Function
LAN ACCESS	Green (blinks)	This LED blinks green if the system is communicating via the high speed LAN port.
AUTO / MANUAL	Red (solid)	This LED is illuminated when the analyzer is currently running a manual sequence. If the LED is off, then the analyzer is running an automatic sequence of preset events.
Busy	Green (blinks)	This LED blinks when an instruction is written to the flash via the keypad or through the application program. The operator should wait until the LED stops blinking before turning the power OFF.
Tx USB	Green (blinks)	This LED blinks green if the unit is transmitting data via the USB connection.
Rx USB	Red (blinks)	This LED blinks red if the unit is receiving data via the USB connection.
ALARM	Red (solid)	This LED indicates that at least one alarm has been triggered.
BYPASS	Yellow (blinks)	This LED blinks yellow if the unit is in bypass mode.
WARNING	Red (solid) Red (blinks)	This LED is used for the following: a) If there is a problem with the primary or backup firmware on start-up this LED will light to indicate copying of a good copy of the firmware from one storage location to the other. b) During a memory-wipe process. c) If the LED is blinking red, it means that the analyzer is currently in Direct Board Control Enable mode, which is triggered through the application program.
KEYPD	Blue	This LED illuminates any time a key on the keypad is pressed. It remains illuminated until the input from the keypad has been processed by the electronics assembly, and no other presses on the keypad will be recognized until this LED turns off.
SERIAL COM	Green	This LED illuminates any time the analyzer is communicating via a serial link. It will illuminate for communications on the RS-232, RS-485, or USB communications ports.

4.3 The Main Page of the LCD Display

The main page of the LCD (Figure 4-2) contains three discrete regions:

- The top two lines are fixed and present the **mV**, **RUN**, **STATE**, and **TIME** status indicators (Section 4.3.1).
- The center of the screen (four lines) shows the calculated concentration for the most recent run (Section 4.3.2).
- The bottom two lines present the definition of the soft keys of the hand held controller (Section 4.3.3).



Figure 4-2: The LCD Display (Main Page)

NOTICE

The information presented by the display is dependent on the system configuration and the parameters that have been selected by the operator. The various screen depictions presented in this section are typical situations, and it is likely that the screen depictions that you observe will be different from what is shown in this discussion.

4.3.1 Status Indicator Lines

The status indicator lines are presented at all times and display the current status if the analyzer.

The **mV** indicator indicates the output of the sensor. The analyzer can be configured to display corrected mV (indicated by mV on the display) or live uncorrected mV (indicated by LmV on the display). The format can be selected as described in Section 5.8.1.

The **RUN** indicator indicates which analysis mode the analyzer is currently in. There are 5 types of gas runs: Sample (**S**), Calibration (**C**), Reference 1 (**R**), Reference 2 (**r**), Zero (**Z**) The run codes are displayed as: {stream #} {Run type} {Run sequence} An example of the run indicator is 1S3, which indicates that the present analysis is for Sample in Stream 1, and this is the third run.

The **STATE** code indicates what state the analyzer is currently in. There are seven possible codes listed in Table 4-2.

Table 4-2: STATE Codes

Code	Meaning
INIT	The sensor is determining the zero and span calibration. This code is seen on power-up and during a user-forced sensor calibration through the keypad.
IDLE	The system is waiting for a measurement from the sensor. This code is seen on power up if the analyzer sequencers are not configured or enabled. This code will also appear after a run if a manual sequence has been selected.
TA	Tape advance in progress. This code is seen at power up, during a user-forced tape advance, and at the end of every analysis cycle.
CSENS	The sensor is performing a current adjustment and then auto-zeros the output so that the output starts at 0mV for the next analysis run. This code is seen at the beginning of every analysis cycle.
SD	Sample Delay. The results obtained during this section of the analysis cycle are considered invalid by the system and are not used in the concentration calculation.
SI	Sample Interval. This is the standard analysis mode in which results are collected to calculate the concentration.
PRG	The system is purging. This code is seen during power up of the analyzer and immediately after a stream change. The system purges for a given period of time before beginning an analysis on the new stream.

4.3.2 Central Region

The present concentration of chlorine is indicated in the center of the display. The display can be configured to read the calculated concentration for the last completed cycle or the live instantaneous reading for the current cycle. The live mode will be indicated by the presence of the letter L before the analysis units.

4.3.3 Display Menus and Sub-menus Descriptions

The bottom two lines of the main page define the four soft keys on the keypad (F1-F4). Each of the keys accesses additional features and the definition of the various keys changes as the operator selects a specific function as described in Sections 4.4 to 4.8.

Table 4-3: LCD Main Screen Function Key Definitions

F Key	Code	Meaning
F1	STRM	Stream menu: Allows the operator to view/edit stream parameters such as gas concentrations, Alarm set-points, gain settings initiating specific gas runs, etc.
F2	ALRM	Alarms menu: Allows the operator to view the analyzer alarm list. This list will show all active alarms.
F3	DISP	Display menu: Allows the operator to view the current status of the Sequencer setup (SQNC), the discrete Input/Outputs (I/O), the current concentration values (READ) for each gas run in the sequence and what is currently scheduled (SCHED) and pending.
F4	CNFG	Configuration menu: Allows the operator to view/change a broad range many parameters on the analyzer.

4.4 Using the Handheld Keypad

The handheld keypad is used in conjunction with the LCD display to access the menus that present a variety of system parameters. The keypad is shown in Figure 4-3.



Figure 4-3: The Keypad

The keypad includes 20 keys. Eleven keys are used to enter numerical data (0-9 and a decimal point), four are used to select F1-F4 and five keys have specific functions as indicated in Table 4-4.

Table 4-4: Function Key Definitions

Key	Function
F1	On the main page (Figure 4-2), the F1 key accesses the Stream (STRM) menu (Section 4.5) and is used to select the stream of interest. On other screens, the F1 key is used as a page-up (PGUP) function key to scroll through multiple menu screens if required or is used to select a sub-menu.
F2	On the main page (Figure 4-2); the F2 key accesses the Analyzer Alarm (ALRM) list (Section 4.6). On other screens, the F2 key is used as an up (UP) function key to scroll through multiple menu screens if required or is used to select a sub-menu.
F3	On the main page, the F3 key accesses the Display (DISP) settings (Section 4.7). On other screens, the F3 key is used as a down (DN) function key to scroll through multiple menu screens if required or is used to select a sub-menu.
F4	On the main page (Figure 4-2); the F4 key accesses the Configuration (CNFG) menu. On other screens, the F4 key is used as a page down (PGDN) function key to scroll through multiple menu screens if required or is used to select a sub-menu.
BYPASS	Pressing this key will put the analyzer into Bypass mode. Pressing this key again will exit Bypass mode.
TAPE ADVANCE	Pressing this key will cause the analyzer to cease the current analysis, advance the tape, and begin a new cycle.
EDIT	Pressing this key on editable items will allow the user to enter in a new value of setting (e.g. ON/OFF) for the active menu item.
EXIT	Exits any menu screen and returns to the main display screen (Figure 4-2).
ENTER	While editing any editable menu item, pressing ENTER will cause the analyzer to accept the newly entered value.

When a menu is presented, the top two lines will always present the system status, the next four lines will present the relevant settings (information) and the bottom two lines will present the soft key definitions. A typical menu (from the STRM menu) is shown in Figure 4-5. There are four lines which present information on a page; if the menu contains more than four lines of information, the additional items can be accessed by pressing the PGUP, UP, DN and PGDN keys (F1-F4).

mV	Run	State	Time
6	1S1	S1	115
Hi	16.00	OFF	
HiHi	18.00	OFF	
DUR	0.00	OFF	
LOCK	4.00	OFF	
F1	F2	F3	F4
PGUP	UP	DOWN	PGDN

Figure 4-4: The Streams Menu

Some parameters can be edited while others are for information only. Note that any parameters that are changed via the keypad will automatically be reflected in the GUI software.

4.5 The Streams Menu

When F1 is selected, the *Stream* menu is presented (Figure 4-5).

mV	Run	State	Time
6	1S1	SI	115
Hi	16.00	OFF	
HiHi	18.00	OFF	
DUR	0.00	OFF	
LOCK	4.00	OFF	
F1	F2	F3	F4
PGUP	UP	DOWN	PGDN

Figure 4-5: First Stream Menu Page

This menu contains more than four items and additional items can be accessed via the DN, PGDN, UP and PGUP keys. For the sake of brevity, we present the items on the menu on a line by line basis rather than showing each page.

- **Hi 16.00 OFF** - This line indicates the set point for the chlorine High Alarm and the current status of the alarm. The alarm set point can be edited by pressing the EDIT key on the keypad while this line is highlighted. A new value can be typed in via the numerical keys and pressing the ENTER key will cause the new value to be accepted.
- **HiHi 16.00 OFF** - This line indicates the set point for the chlorine High High alarm and the current status of the alarm. The alarm set point can be edited by pressing the EDIT key on the keypad while this line is highlighted. A new value can be typed in via the numerical keys and pressing the ENTER key will cause the new value to be accepted.
- **DUR 5** - This line indicates the length of time in seconds that the chlorine High High alarm set point has to be exceeded before the alarm will be activated. This parameter can be edited by pressing the EDIT key on the keypad while this line is highlighted. A new value can be typed in via the numerical keys and pressing the ENTER key will cause the new value to be accepted.
- **LOCK 4.00 OFF** - This line is used to indicate if the Lock Stream alarm should be enabled for the chlorine measurement to change the setting, press the EDIT button. The operator will be prompted to enter the desired value and press the ENTER key on the keypad.
- **GAIN 100.0 100.0** - This line is used to set the gain. To change the setting, press the EDIT button. The operator will be prompted to enter the desired value and press the ENTER key on the keypad. In *Edit* mode, the left value changes while the right value stays at the previous value (in case you cannot recall what the previous value was).
- **CALGAS 18.0 18.0** - This line is used to indicate the concentration of the calibration gas. To change the setting, press the EDIT button. The operator will be prompted to enter the desired value and press the ENTER key on the keypad. In *Edit* mode, the left value changes while the right value stays at the previous value (in case the operator cannot recall what the previous value was).
- **OFFSET 0.0 0.0** - This line is used to indicate the current value of the zero offset. To change the setting, press the EDIT button. The operator will be prompted to enter the desired value and press the ENTER key on the keypad. For additional information, see Section 5.10.4.3. In *Edit* mode, the left value changes while the right value stays at the previous value (in case the operator cannot recall what the previous value was).
- **OGAS 0.1 0.1** - This line is used to indicate the concentration of chlorine in the zero gas. To change the setting, press the EDIT button. The operator will be prompted to enter the desired value and press the ENTER key on the keypad. In *Edit* mode, the left value changes while the right value stays at the previous value (in case the operator cannot recall what the previous value was).

- **CAL** **OFF** - This field is used to initiate a calibration run. To initiate the calibration run press the EDIT button, and press ENTER to toggle the status from OFF to ON. The analyzer will run the calibration according to the setup of the Calibration run (see Section 5.10.4) and then revert back to the auto-sequence.
- **REF1** **OFF** - This field is used to initiate the Reference 1 run. To initiate the Reference 1 run press the EDIT button, and press ENTER to toggle the status from OFF to ON. The analyzer will run the Reference 1 run according to the setup of the Reference 1 run (see Section 5.10.4) and then revert back to the auto-sequence.
- **REF2** **OFF** - This field is used to initiate the Reference 2 run. To initiate the Reference 2 run press the EDIT button, and press ENTER to toggle the status from OFF to ON. The analyzer will run the Reference 2 run according to the setup of the Reference 2 run (see Section 5.10.4) and then revert back to the auto-sequence.

4.6 The ALARMS Page

If F2 is selected from the main screen, a list of all alarms is presented (e.g. Off-line). The Alarm LED will be lit when an alarm condition has been detected. The possible alarms are listed in Table 4-5. A detailed discussion of the various alarms is presented in Section 5.6.

Table 4-5: Alarms

General System Alarms	High Temperature Alarm Low temperature Alarm Sensor LED Current RTC Battery Max Tape Advance Alarm Low Tape Alarm Tape Length Alarm Tape Movement Alarm Sensor Calibration Alarm Bypass DC Power Alarm AC Power Alarm
Analog Input Alarms	AI#1 > Limit AI#1 < Limit AI#2 > Limit AI#2 < Limit AI#3 > Limit AI#3 < Limit AI#4 > Limit AI#4 < Limit
Analysis Alarms - Sample	High Alarm High High Alarm Deviation Lock
Analysis Alarms - Reference 1	High Alarm High High Alarm Deviation Lock
Analysis Alarms -Reference 2 ⁾	High Alarm High High Alarm Deviation Lock
Analysis Alarms – Zero ⁾	High Alarm High High Alarm Deviation Lock
Analysis Alarms – Calibration ⁾	High Alarm High High Alarm Deviation Lock

4.7 The Display Menu

When F3 is pressed on the main page, the Display menu appears as shown in Figure 4-6. The function keys lead to four menus that are described in Sections 4.7.1 through 4.7.4

mV	Run	State	Time
6	1S1	S1	115
10.0 ppm			
F1	F2	F3	F4
SQNC	IO	READ	SCHED

Figure 4-6: Display Menu

4.7.1 The SQNC Menu

A typical SQNC (Sequence) menu is presented in Figure 4-7. The sequence is entered via the GUI (Section 5.14) and indicates the order of measurements that occur during a cycle. The sequence cannot be edited via the hand held keypad.

mV	Run	State	Time
6	1S1	S1	115
• AUTO			
• S1: SAMPLE			
• S1: REF1			
F1			F4
PGUP			PGDN

Figure 4-7: SQNC Menu

When F4 (PGDN) is pressed, additional lines in the sequence will be displayed.

4.7.2 IO Menu

A typical IO (*Input/Output*) menu is presented in Figure 4-8. The values that are presented are the live values for the analog (AO) outputs, digital (DO) outputs and relays that have been activated via the GUI and cannot be edited via the hand held controller

mV	Run	State	Time
6	1S1	S1	115
Analyzer IO State:			
AO_1	mA		4.06
AO_2	mA		4.09
AO_3	mA		4.11
F1	F2	F3	F4
PGUP			PGDN

Figure 4-8: The IO Menu

4.7.3 Analyzer Reading Menu

A typical *Analyzer Reading* menu is presented in Figure 4-9. The values that are presented are the most recent value for the various reading for each analysis (e.g. S1:SAMPLE 10.0 means that the last reading for chlorine was 10 ppm) and cannot be edited.

mV	Run	State	Time
6	1S1	S1	115
Analyzer Reading:			
S1:	SAMPLE	10.0	
S1:	REF1	6.7	
S1:	REF2	8.9	
F1	F2	F3	F4
PGUP			PGDN

Figure 4-9: Analyzer Reading Menu

4.7.4 Analyzer Schedule Menu

The *Analyzer Schedule* menu (Figure 4-10) shows what stream is currently being analyzed and what streams (if any) are pending.

mV	Run	State	Time
6	1S1	S1	115
Analyzer Schedule:			
S1:	SAMPLE	ON	
S1:	REF1	PENDING	
F1	F2	F3	F4
PGUP			PGDN

Figure 4-10: Analyzer Scheduler Menu

4.8 The Configuration Menu

When CFNG (F4) is pressed on the Main page, the display appears as shown in Figure 4-11. The function keys lead to four menus that are described in Sections 4.8.1 through 4.8.4

mV	Run	State	Time
6	1S1	S1	115
Configure ?			
F1	F2	F3	F4
GEN	DIO	AIO	MSEQ

Figure 4-11: The Configuration Page

4.8.1 The Gen Menu

When GEN (F1) is selected on the *Configuration* page (Figure 4-12), the *General* menu is presented (Figure 4-16).

mV	Run	State	Time
6	1S1	S1	115
• TAPE 224.95			
• ACK_AL OFF			
• L: mV OFF			
• L:ppm OFF			
F1	F2	F3	F4
PGUP	UP	DOWN	PGDN

Figure 4-12: The General Menu

- **TAPE** - indicates the tape length that remains. The value can be changed (e.g. when the tape is replaced) by pressing the EDIT key on the keypad. A query will be presented and the appropriate tape length should be entered, followed by the ENTER key.
- **ACK_AL** - This field is used to acknowledge all latched alarms. To acknowledge the latched alarms, press the EDIT key and use the ENTER key to toggle the value to ON. Note that any latched alarms will not unlatch if they are still in the alarm condition.
- **L mV** - This field is used to set the mV on the display to corrected mV (indicated by mV on the display) or live uncorrected live mV (indicated by LmV on the display). This function (On/OFF) can be edited by pressing the EDIT key followed by the ENTER key.
- **L ppm** - This field is used to set the concentration reading on the display to the last calculated value (indicated by the absence of the L in front of the analysis units) or to the current analysis live value (indicated by the presence of the L in front of the analysis units). This function (On/OFF) can be edited by pressing the EDIT key followed by the ENTER key.
- **DAY** - presents the day of the week and cannot be edited.
- **TIME** - presents the present time and cannot be edited.
- **MODBUS ADD** - Presents the current Modbus unit address. This parameter can be edited by pressing the EDIT key, typing in a new value followed by the ENTER key.
- **CURRENT** - Presents the sensor LED current in mA.
- **TEMP** - indicates current temperature of the sensor block.
- **SENSOR** - Presents the sensor firmware revision number and cannot be edited.
- **FIRM** - indicates the analyzer firmware revision number and cannot be edited.

- **DIAGNOSTICS** - If the *Diagnostics* option is selected, a series of hardware diagnostics will be performed when the analyzer is powered up. If Diagnostics is not selected, the hardware diagnostics will not be performed. This function (ON/OFF) can be edited by pressing the EDIT key followed by the ENTER key.
- **COLD_R** - resets all configuration parameters to the factory default. This will take about 1 minute and the analyzer will reboot. This function (ON/OFF) can be edited by pressing the EDIT key followed by the ENTER key.
- **SEN. CAL** - This field is used to initiate a sensor calibration (see Section 7.3).

4.8.2 The DIO Menu (Digital Inputs/Outputs)

When DIO (F2) is pressed on the *Configuration* page (Figure 4-11), the *DIO* display which describes the Digital Outputs appears as shown in Figure 4-13.

mV	Run	State	Time
6	1S1	S1	115
PRESS OFF	DI-POL	Edit	
PRESS OFF	DI-POL	Edit	
CAL OFF	DI-POL	Edit	
WET 1 OFF	DI-POL	Edit	
F1	F2	F3	F4
PGUP	Up	Down	PGDN

Figure 4-13: The DIO Display

The status of the items on this menu can be edited by pressing the EDIT key followed by the ENTER key. Each item can be edited (e.g. there are 4 wet lines 4 dry lines, etc); and can be accessed via the function keys). The items on this menu are listed in Table 4-6.

Table 4-6: DIO Menu

PRESSURE	DI-POL (a)
PRESSURE	DI-POL (a)
CALIBRATION	DI-POL (a)
WET 1-4	DI-POL (a)
DRY 1-4	DI-POL (a)
RELAY 1-6	FS-POS (b)
RELAY 1-6	LCH_EN (c)

- DI-POL indicates the polarity of each of the available discreet inputs. See Section 5.11 and 5.12.
- FS-POS shows the fail safe position of each of the six relays.
- LCH_EN indicates if the alarm associated with each relay is latching or non-latching.

4.8.3 The AIO Menu (Analog Inputs/Outputs)

When AIO (F3) is pressed on the *Configuration* page (Figure 4-11), the AIO display which describes the analog outputs appears as shown in Figure 4-16. The central column is the analog input or output full scale, which can be edited, by pressing the EDIT button, entering the desired value and pressing ENTER and the right column is the present reading

mV	Run	State	Time
6	1S1	S1	115
A1_1		50.00	-12.38
AI-2		50.00	-12.39
AI_3		50.00	-12.44
AI_4		50.00	60.74
F1	F2	F3	F4
PGUP	Up	Down	PGDN

Figure 4-14: The AIO Display

4.8.4 The MSEQ Menu (Manual Sequencer)

When MSEQ (F4) is selected on the *Configuration* menu (Figure 4-11), the MSEQ menu is presented. A typical menu is shown in Figure 4-15. This menu allows the user to initiate manual sequences (for additional information, see Section 5.14.3).

mV	Run	State	Time
6	1S1	S1	115
SEQNC		OFF	
Manual		OFF	
SEQ 1		OFF	
SEQ 2		OFF	
F1	F2	F3	F4
PGUP	Up	Down	PGDN

Figure 4-15: The MSEQ Menu

Section 5 Graphical User Interface (GUI)

5.1 Opening the Program

NOTICE

This discussion assumes that the analyzer has been connected to the personal computer. A detailed discussion of the protocol to connect the two units is presented in Section 3.4.

The *Graphical User Interface* (GUI) is a Windows-based application program which provides the analytical results and allows the operator to set a broad range of instrumental parameters. When the program is first opened, the window shown in Figure 5-1 is presented.

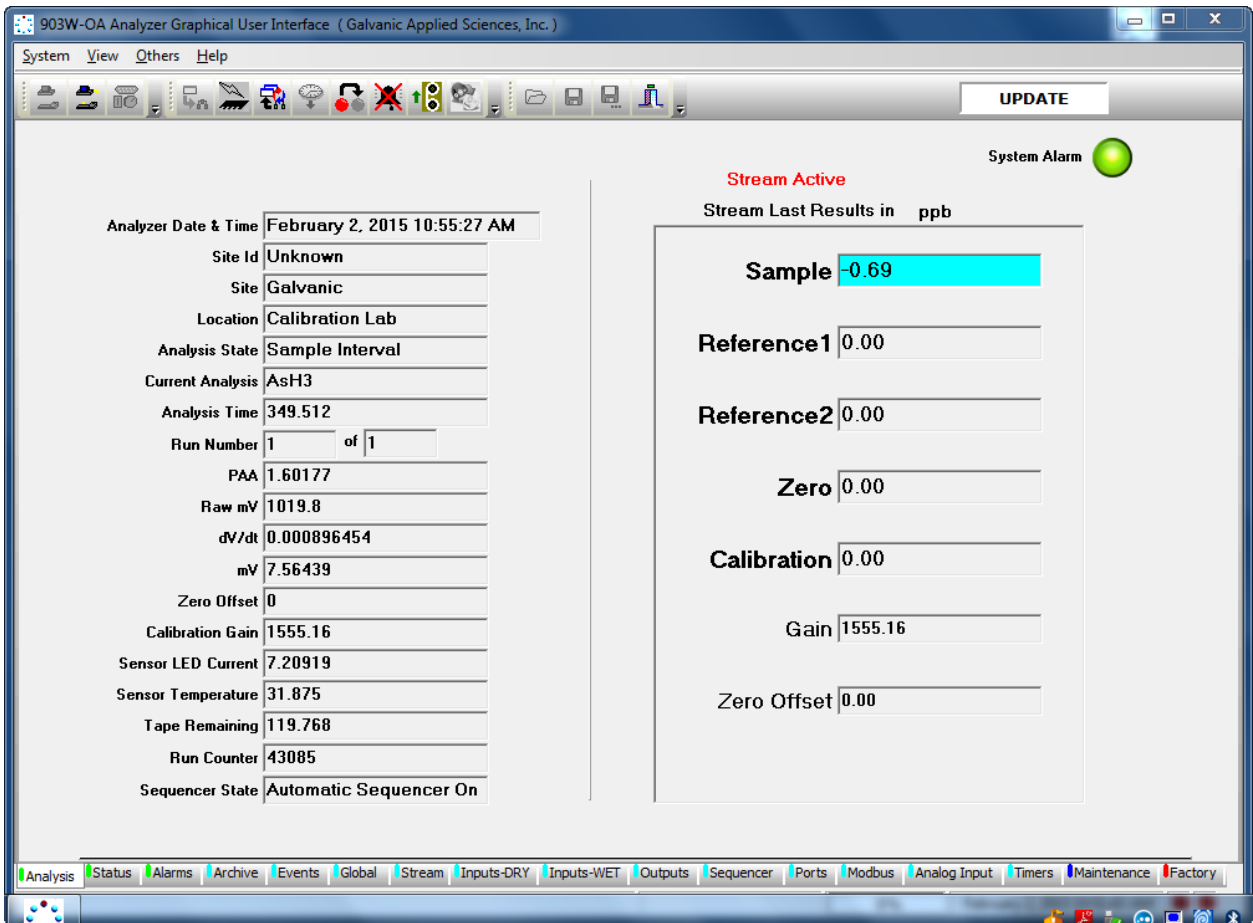

Figure 5-1: Graphical User Interface Window

To log onto the system:

- a) Press the *Logon* button (Figure 5-2). The computer will communicate with the analyzer and transfer the present analyzer status from the analyzer to the computer. During this time a dialog box will present a progress bar indicating the status of the transfer.



Figure 5-2: Logon Button

- b) Once the data transfer is complete (which may take a minute or two), the *Select Mode* dialog box (Figure 5-3) will be presented.

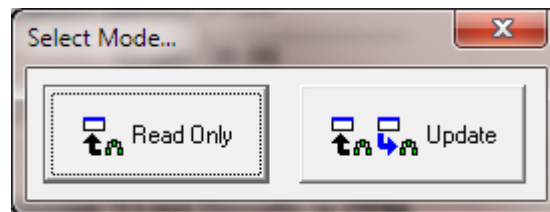

Figure 5-3: Select Mode Dialog Box

- c) The *Read Only* option will allow the operator to view data, parameters and analyzer settings, but will not allow the operator to change parameters settings while the *Update* option allows the operator to change them. If the *Update* option is selected, the operator is required to enter a password. The default password is 2222, and can be changed as described in Section 5.2.1.

NOTICE

If the GUI is in *Read Only* mode and the operator desires to use the *Update* mode, select the *Update Mode* command on the *Others* menu. A dialog box to enter the password will be presented.

5.2 Components of the Main Window

5.2.1 Menu Bar

The *Menu* bar includes four menus:

- a) *System Menu* - The *System* menu contains the *Exit* command which can be used to close the GUI (it does not turn the analyzer off).
- b) *View Menu* - The *View* menu allows the user to decide which toolbars to display. A drop down menu presents four options - *Communicate ToolBar*, *Operation ToolBar*, *General ToolBar* and *Upgrade Window*. The first three options allow the user to display the appropriate toolbar by clicking on the box adjacent to the name (to remove the toolbar, click to remove the check mark). A discussion of the toolbars is presented in Section 5.2.2. The *Upgrade Window* option is used to install new software and is discussed in Appendix A.
- c) *Others Menu* - The *Others* menu contains:
 - *Update Mode* - used to change from *Read Only* mode to the *Update* mode of operation. A dialog box is presented to enter the password.
 - *Change Password* - allows the user to change the password for the Update Mode. The original password must be entered and the new password must be entered two times in the dialog box shown in Figure 5-4.



Figure 5-4: Change Password Dialog Box

- *Reboot* - accesses the dialog box shown in Figure 5-5. Pressing the *OK* button will cause the analyzer to reset. Any changes that have not been written to the computer but not transferred to the analyzer will be lost if this option is selected. The *Reset* option is unavailable if the program is in read-only mode.

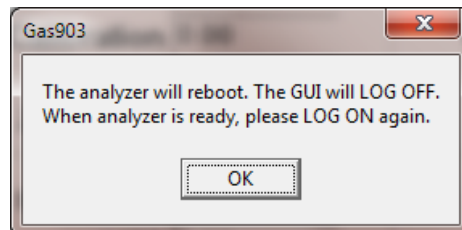

Figure 5-5: Reboot Dialog Box

- d) *Help* Menu - The *Help* menu contains:
- *Wiring Book* - the wiring schematics which are also presented in Section xx of this manual.
 - *Manual* - an on-line copy of this manual.
 - *About* - presents the *About* dialog box (Figure 5-6) which shows the version number of the GUI currently in use. Please provide the version number if you contact Galvanic Applied Sciences for assistance.

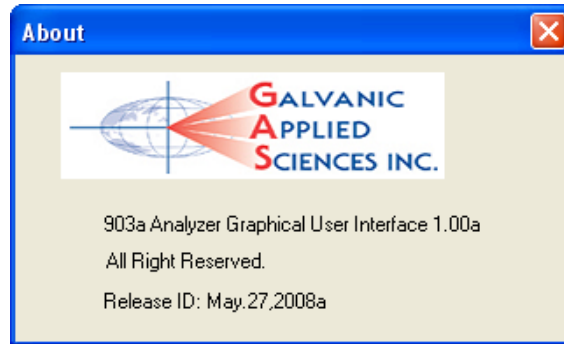

Figure 5-6: About Dialog Box

5.2.2 The Tool Bar



The buttons on the tool bar are grouped into three distinctive groups that the user can choose to show or hide using the *View* menu (Section 5.2.1).

In addition, a field indicates the status of the analyzer and can contain three possible values - **OFF LINE**, which means that the GUI is not connected to an analyzer; **READ ONLY**, which means that the analyzer is in *Read Only* mode; and **UPDATE**, which means that the analyzer is in *Update* mode.

5.2.2.1 Communicate Toolbar

The *Communicate* toolbar contains the buttons that control the communications between the GUI and the analyzer, as well as allow the user to set the communications link parameters. Table 5-1 shows the buttons in the *Communicate* Toolbar.









Table 5-1: Communicate Toolbar Buttons

Button	Name	Function
	Logon	Establishes a communication link between the GUI and the analyzer.
	Logoff	Disconnects the communication link between the GUI and the analyzer.
	Communications Settings	Allows the user to set up the communications options for the link between the GUI and the analyzer.

5.2.2.2 Operation Toolbar

The *Operation* toolbar contains several buttons that control various aspects of the operation of the analyzer and the GUI. Table 5-2 shows the buttons in the Operation Toolbar.





Table 5-2: Operation Toolbar Buttons

Button	Name	Function
	Temporary Write to Analyzer	Writes any configuration changes in the active screen to the analyzer's volatile memory.
	Permanent Write Configuration to Analyzer	Writes any configuration changes in the GUI first to the volatile memory and then writes the changes to non-volatile flash memory. Any changes that the user wishes to be permanent and to be present if the analyzer is powered off must be written to flash. If the analyzer is powered down before changes are written to flash, those changes will be lost.
	Poll Page Once	Reads back all the data points on the current screen. Pushing this button allows the user to check and ensure that any changes written to the analyzer have been accepted.
	Synchronize Time	Updates the on-board real time clock in the analyzer to the time and date set on the linked computer.
	Acknowledge All Latches	Returns all latches that may have been triggered by alarms to their default configuration.
	Bypass Alarms	Puts the analyzer into bypass mode, where events associated with alarms (relays, solenoids, etc) are ignored. When this button is depressed, the bypass mode is enabled. When the button is not depressed, bypass mode is disabled.
	Tape Advance	Instructs the analyzer to run the motor to advance the tape and perform a calibration of the sensor block. Pressing this button is the equivalent of cycling the power to the analyzer.
	Upgrade Firmware	Updates the analyzer with the latest firmware. This is done offline but the user must ensure that the correct communications port has been selected.

5.2.2.3 General Toolbar

The *General* toolbar contains several buttons that allow the user to load and save configuration files, print configurations, and open the context selective help file. Table 5-3 shows the buttons in the General Toolbar. A saved configuration file can be opened, edited and re-saved when offline (not connected to the analyzer).

Table 5-3: General Toolbar Buttons

Button	Name	Function
	Open	Opens a saved analyzer configuration file. This can be done online or offline.
	Save Current Configuration	Saves current configuration to a file. If the configuration has been saved to a file previously, pressing this button will overwrite the existing configuration file. If offline, a saved configuration file needs to be opened before one can be saved.
	Save Configuration to a new file	Saves current configuration to a new file with a file name of the user's choosing. If offline, a saved configuration file needs to be opened before one can be saved.
	Exit	Pressing this button will cause the GUI to close. It is advisable to log off the analyzer prior to exiting the GUI.

5.2.3 Application Screens (Tabs)

The GUI is a *Tab* driven system which includes 17 tabs listed in Table 5-4. Each tab contains information about the analyzer and most allow for editing of system parameters (in *Update* mode). The specifics of each tab will be discussed in Section 5.4 to 5.20.

Table 5-4: Function of Each Tab

Screen Name	Function
Analysis	Allows the user to see the current status of the analyzer, including concentration readings and input and output status.
Status	Provides the current status of the analog outputs, relays, solenoids, analog inputs, discrete inputs, and what voltage input source is in use.
Alarms	Allows the operator to view all enabled system alarms.
Archive	Allows the operator to access the numerous archives that store live data, hourly and daily averages, as well as other user configurable archives.
Events	Allows the operator to access the <i>Event Log</i> , which keeps track of all the configuration changes and events that the analyzer has experienced.
Global	Allows the operator to change settings that affect the global operation of the analyzer, such as stream purge times.
Streams	Allows the operator to change settings specific to each stream; normal, zero, reference, and calibration.
Inputs-DRY	Allows the operator to configure the four discrete (Dry) inputs of the analyzer.
Inputs-WET	Allows the operator to configure the four discrete (Wet) inputs of the analyzer.
Outputs	Allows the operator to configure the behaviour of the relays, solenoids and analog outputs.
Sequences	Allows the operator to configure the analyzer gas run event sequences in either, automatic or manual or both.
Ports	Allows the operator to view the settings of the analyzer's communications ports - RS-232, RS-485, and USB.
Modbus	Allows the operator to configure Modbus lists, including the type of Modbus list and the data points that are outputted to Modbus.
Analog inputs	Allows the operator to configure the 4 analog inputs including the live pressure and temperature readings and related alarm set points.
Timers	Allows the operator to schedule conditional gas run operational requests on an hourly, daily or weekly basis.
Maintenance	Allows the operator and service personnel to have greater control over the electronics board, for testing analog outputs, relays, and solenoids.
Factory	Reserved for factory and service personnel

5.2.4 Status Bar

The *Status* bar, which is located at the bottom of the window, presents the update status, the present time/date and traffic lights to indicate the status of communication between the analyzer and the computer.

5.3 Communication between the Computer and the Analyzer

When communication between the computer and the analyzer is established, the GUI downloads the current status of the analyzer. If a change is made to any data on a tab, it must be transmitted to the analyzer to be effected.

NOTICE

If you make a change to an analyzer parameter via the GUI, make certain that you transmit it to the analyzer before you open another tab. If you do not transmit it to the analyzer and go to another tab, the change will be lost.

Information can be transferred from the computer to the analyzer via the following two buttons on the button bar:



Write Current Page to Analyzer Button

As you go through the tabs and make the desired changes, the *Write Current Page to Analyzer* button allows you to store and view your analyzer configuration and its behavior before you make a final decision. If you switch the power off to the analyzer or perform a *Reboot*, the analyzer will revert to its original configuration and all the changes will be lost.

To prevent the loss of parameter changes, all the changes must be permanently saved to the analyzer as described below.



Permanent Configuration Write to the Analyzer Button

When all the desired changes have been made and saved to the analyzer by using *the Write Current Page to Analyzer* button; the *Permanent Configuration Write to the Analyzer* button is used to make them permanent.

When the *Permanent Configuration Write to the Analyzer* button is pressed, a command to the analyzer will be sent that will start the process of copying data from analyzer memory to the analyzer hard drive. This process takes about 30 seconds to complete. After this step, all the changes are permanently stored to the analyzer.

5.4 The Analysis Tab

The *Analysis* tab (Figure 5-7) is the default tab of the GUI and allows the operator to see the status of many facets of the analyzer all at a glance. The GUI automatically polls the analyzer every three seconds, causing this page to be updated continuously.

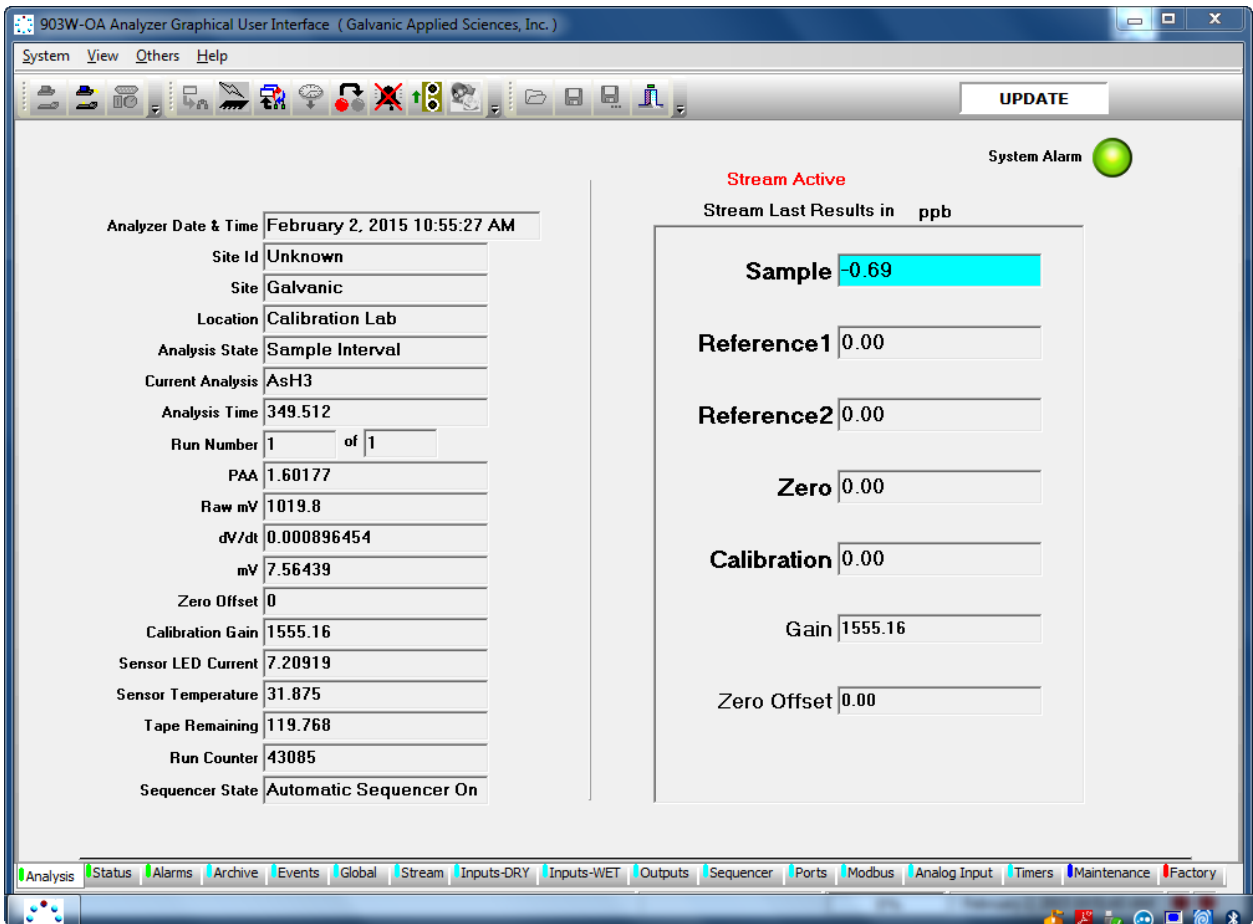

Figure 5-7: Analysis Tab

5.4.1 Field Names and Explanations

The left side of the Analysis tab includes 20 fields which provide general information about the status of the analyzer (Table 5-5). The first four fields can be edited as described in Section 5.9 but the rest cannot be edited.

Table 5-5: Analysis Window Fields

Field Name	Explanation
Analyzer Date and Time	Shows the current date and time on the analyzer. It is important that this be set correctly so that the archived data has the correct time stamp. If this is not correct, ensure that the computer's time and date is correct, and then press the <i>Synchronize Time</i> button.
Site ID	The analyzer serial number
Site	Shows the site name that the analyzer is installed at
Location	Shows the specific location that the analyzer is installed at.
Analysis State	Shows the current state of the analyzer. The various analysis states are shown in Table 4-2.
Current Analysis	Shows the current run type being performed by the analyzer. The run type name that is displayed is entered under <i>Streams Name</i> field on the <i>Streams</i> tab.
Analysis Time	Shows the number of seconds elapsed since the beginning of the current analysis cycle.
Run Number	Shows the current number of runs of the current analysis type, as well as the total number of runs of this type to be performed.
Trended Reading	Shows a trended concentration reading that takes the values of several past concentration readings of the same run type into account.
PAA	Shows the live Predictive Alarm Analysis (PAA), $(dv/dt * gain)$
Raw mV	Shows the current raw photodiode detector output, in millivolts. This reading starts at around 1000mV at the start of an analysis, and drops as the analysis proceeds. This value can be displayed as live mV (LmV) on the display (see Section 4.3.1).
dV/dT	Shows the rate of change in sensor output.
mV	Shows the absolute value of the sensor output, increasing from zero at the beginning of an analysis. This value can be displayed as corrected mV (mV) on the display (see Section 4.3.1).
Zero Offset	Shows the value subtracted from all concentration readings. This value is the parameter that must be subtracted from a reading taken on gas containing no chlorine in order to make the analyzer read approximately 0.00ppm.
Calibration Gain	Shows the value that the dv/dt (rate of stain formation on the tape) is multiplied by in order to produce a real concentration reading.
Sensor LED Current	Shows the current used to ensure a reading of 1000mV is obtained by the sensor block on pure white tape.
Sensor Temperature	Shows the current ambient temperature at the sensor block (in °C).
Tape Remaining	Shows the length of tape, in feet, remaining in the reel. See Section 5.6.1 for more information on how this is calculated.
Run Counter	Shows the current number of runs of all types carried out by the analyzer since it was first started up.
Sequencer State	Shows if the sequencer is currently in an automatic or manual state.

5.4.2 Analysis Data

The data for the analysis stream is presented. The data presented is the last or current results. If an operation is in progress, the appropriate field will be highlighted in blue. The field that is highlighted in yellow is the next operation to be executed in the queue. The stream field definitions are listed in the table. If an operation is setup to run through the usage of timers (located on the *Timers* Tab (Section 5.18) the operation to be executed next will not be highlighted until it has reached its start time and only after the current operation has finished will the operation in the queue commence.

Table 5-6: Stream Fields

Sample	The <i>Sample</i> field either shows the current analysis reading if highlighted blue or the last reading when that stream was run.
Reference 1	The <i>Reference 1</i> field either shows the current analysis reading if highlighted blue or the last reading when that stream was run. A reference gas is used as a periodic calibration check and cannot change the gain
Reference 2	The <i>Reference 2</i> field either shows the current analysis reading if highlighted blue or the last reading when that stream was run. A reference gas is used as a periodic calibration check and cannot change the gain
Zero	The <i>Zero</i> field either shows the current analysis reading if it highlighted blue or the last reading when that stream was run. The Zero run is a way to check what the analyzer will read on a gas that contains no chlorine. Running a zero run will result in a new zero offset being calculated for the analyzer.
Calibration	The <i>Calibration</i> field either shows the current analysis reading if highlighted blue or the last reading when that stream was run. The calibration is used to automatically calibrate the analyzer and calculate a new gain factor.
Gain	The present gain for the stream measurement.
Offset	The present offset for the stream measurement.

5.5 Status Tab

The *Status* tab (Figure 5-8) provides the current status of the Analog Outputs, Relays, Solenoids, Analog Inputs and Discrete Inputs and indicates which voltage input source is in use. In some cases the activation or deactivation of the status indicators may suggest that an alarm is associated with it.

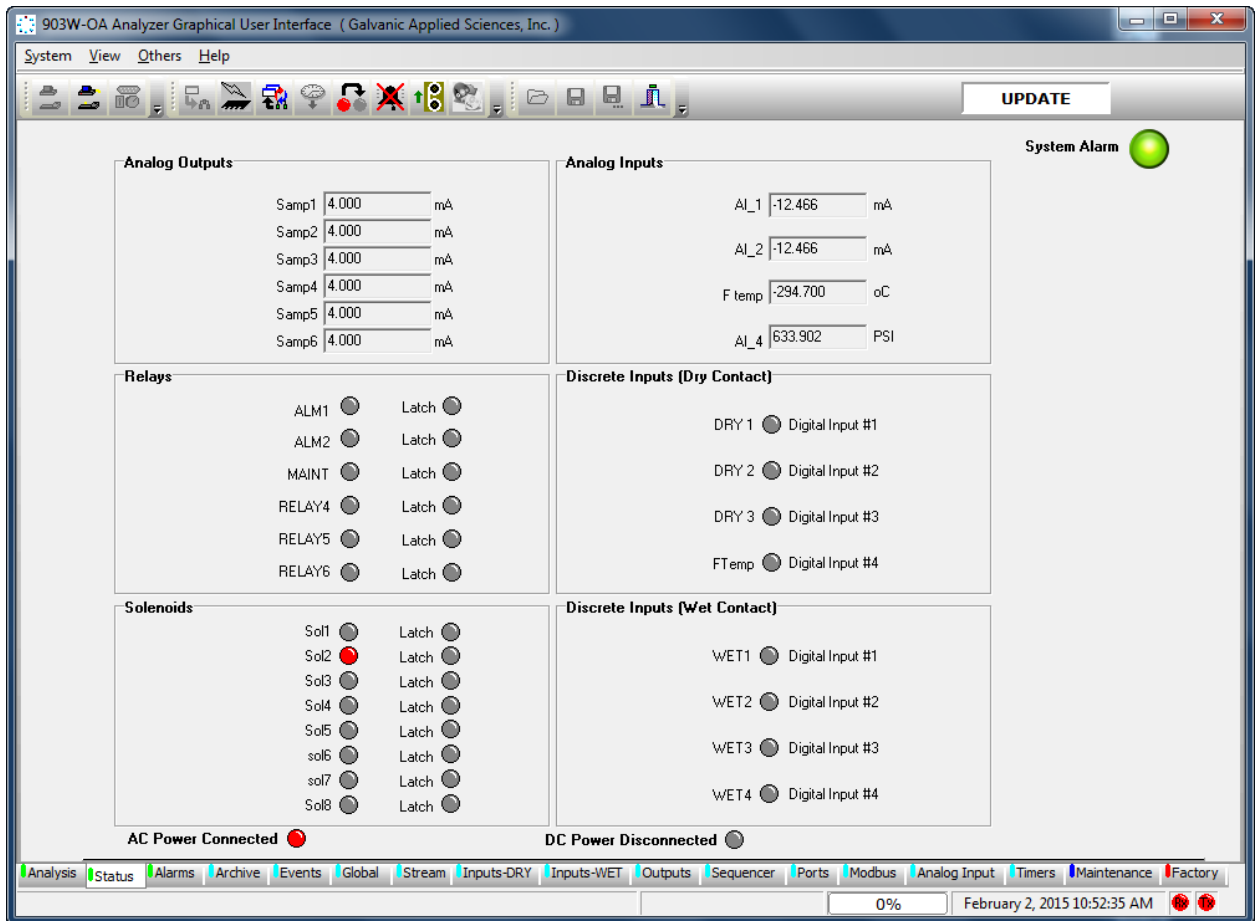

Figure 5-8: Status Tab

Analog Outputs - shows the current output (from 4 to 20mA), of the six analog outputs on the analyzer electronics board. Analog outputs can be configured from the GUI (Section 5.16).

Relays - shows the current status of the six relays. The circle beside each of the relay titles indicates the status. A red colour means that the relay has been triggered, be it by an alarm or some other trigger, while a grey colour means that the relay has not been triggered.

Solenoids - shows the current status of the solenoid drivers on the analyzer electronics board. If the analyzer is not configured with any solenoids, this box can be ignored. A grey circle beside a solenoid label indicates that the solenoid is de-energized, while a red circle indicates that the solenoid is energized. The box labeled *Analog Inputs* shows the current values of each input.

Discrete Inputs (Dry Contact) - shows the current status of the four dry discrete inputs on the electronics board. These discrete inputs can be such things as low-pressure switches, temperature switches or on/off switches used to initiate specific runs. A red circle beside a discrete input label indicates that the particular discrete input has been triggered, while a green circle indicates that the particular discrete input has not been triggered. Setting up discrete inputs is described in Section 5.11.

Discrete Inputs (Wet Contact) - shows the current status of the four wet discrete inputs on the electronics board. These discrete inputs can be such things as remote calibration etc. A red circle beside a discrete input label indicates that the particular discrete input has been triggered, while a green circle indicates that the particular discrete input has not been triggered. Setting up discrete inputs is described in Section 5.12.

5.6 Alarms Tab

The *Alarms* tab allows the user to view the status of the analyzer alarms. Alarms such as the pressure switch alarms will be presented on the analyzer status tab under the *Discrete Input (Dry Contact)* area and on the analyzer display alarm LED.

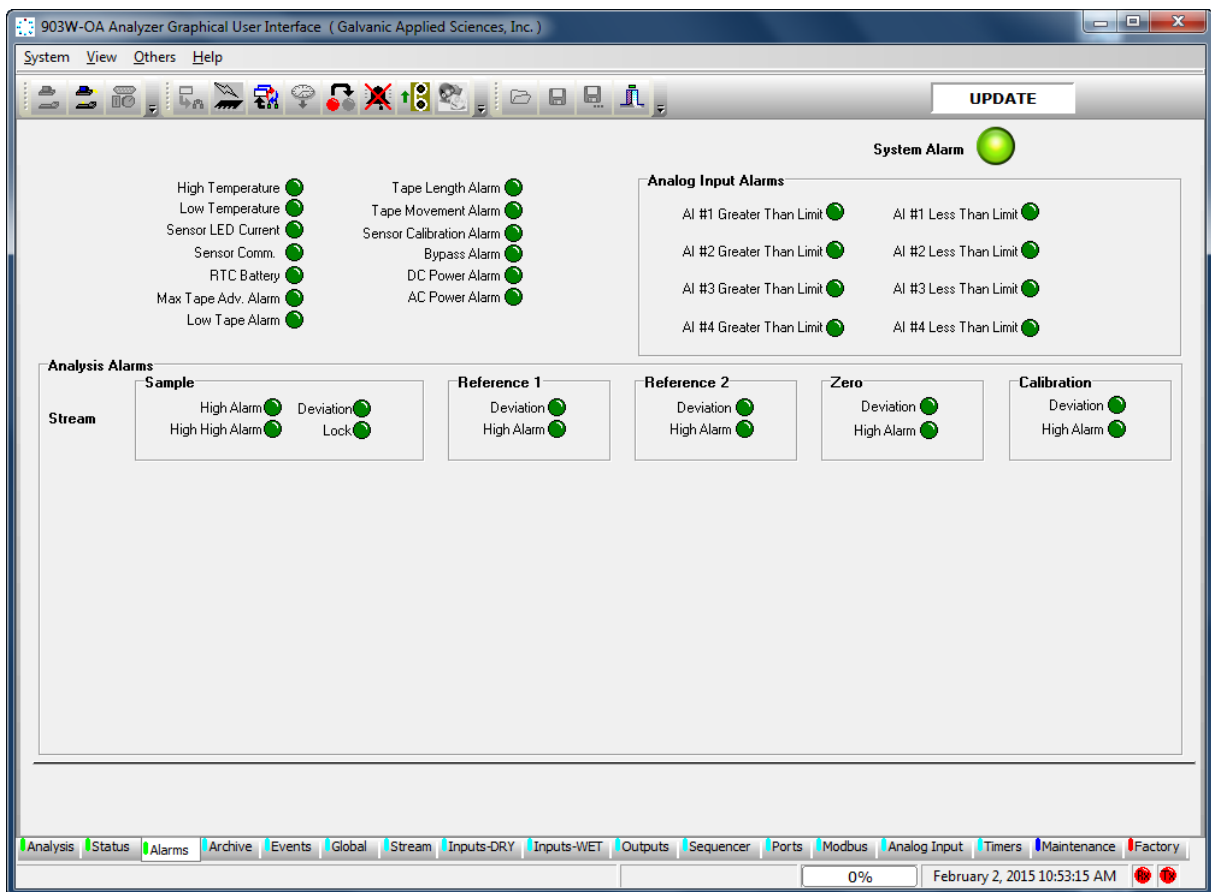

Figure 5-9: Alarm Tab

The *Alarms* Tab is divided into 3 sections:

- Global Alarms (Section 6.5.1)
- Analog Input Alarms (Section 6.5.2)
- Analysis Alarms (Section 6.5.3)

5.6.1 Global Alarms

The 13 alarm references and their associated indicators in the upper left corner are referred to as global alarms. These alarms are non-analysis related alarm parameters that affect all streams identically and are related to hardware and other physical parameters that affect the operation of the analyzer. In many cases, the set point for these global alarms is user configurable. Each alarm can be configured to be active or not active and to trigger certain outputs, either solenoids or relays.

- *High Temperature* - The high temperature alarm will be triggered if the temperature experienced by the sensor block's on-board temperature sensor exceeds the set-point value, in °C.
- *Low Temperature* - The Low Temperature alarm will be triggered if the temperature experienced by the sensor block's on-board temperature sensor goes below the set-point value, in °C.
- *Sensor LED Current* - If the sensor current rises above the set-point value, the alarm is triggered, as there is likely a problem with the sensor block or the sample chamber is dirty. The set-point for this alarm is configured at the factory and should not be changed.
- *Sensor Comm* - The sensor communications alarm is an alarm that triggers if the unit is no longer able to communicate between the motherboard and the sensor block. If this alarm triggers, the unit will no longer function correctly.
- *RTC Battery* - The battery alarm will be triggered if the voltage from the on-board clock battery, which maintains the analyzer's real-time clock should the power fail or drops below a hard-coded value. It can also be triggered if an invalid time is detected.
- *Maximum Tape Advance* - The maximum tape advance alarm will be triggered if the motor advances the tape more than a certain number of rotations without getting a corresponding signal from the pulse counter that controls the tape advance. If this alarm triggers, it will generally indicate a problem with the encoder. The length of the maximum tape advance can be set by the user, but it is advised to leave this set at the factory default.
- *Low Tape* - The analyzer can be configured with an optional optical low tape sensor (see Section x.xx). If this alarm is triggered, it means that the tape is very low and should be replaced soon. The *Low Tape* alarm, should it be installed, is triggered when there is approximately 15 feet of tape remaining on the reel.
- *Tape Length* - A low tape alarm can also be triggered based on the amount of tape that is calculated to be remaining by the pulse counter. The alarm will trigger when the length of tape calculated to be remaining, in feet, drops below the number set in this field. For this alarm to work correctly, it is essential that the length of tape in the reel be reset to the correct length value (usually 300 or 350 feet) in the *Global* tab whenever a tape is replaced.
- *Tape Movement* - If the pulse counter no longer receives any pulses when the tape is advanced by the motor, this alarm is triggered. Tape Movement and maximum tape advance alarms may be triggered by the same problem, so both should be analyzed. Possible causes of a tape movement alarm include running the analyzer out of tape, tape breakage, jamming of the encoder, motor failure and improper tape installation.

- *Sensor Calibration* - If the analyzer is unable to adjust the detector output to 1000mV on white tape even after raising the sensor current to the maximum allowable value, the sensor calibration alarm will be triggered. This alarm will typically be triggered if the tape does not move correctly and the stain becomes exceptionally dark before the next analysis begins, or if there is no tape present.
- *Bypass* - Indicates that the analyzer is in the Bypass mode.

5.6.2 Analog Input Alarms

The top right side of the *Alarms* tab presents eight analog Input alarm references and their associated indicators. The four analog Input *Greater Than Limit* and four *Less Than Limit* fields refer to alarm set points set on the *Analog Inputs* tab and will be discussed in more detail in Section 5.17.

5.6.3 Analysis Alarms

The bottom half of the tab presents the analysis alarms for each of the streams. Each stream has 6 available types of gas runs, each with its own set of alarms.

- *High Alarm* - is the first warning set point in a concentration range where the operator may need to be alerted of a situation in the process.
- *High High Alarm* - is the second warning set point in a concentration range where the operator may need to take actions to alleviate this alarm. Many users will use this set point to "Shut in" the process being monitored.

Deviation Alarm - is an alarm when consequent runs vary from each other by a greater percentage than the value set on the *Streams* tab (Section 5.10).

- *Lock Alarm* - This alarm will lock the analyzer in what ever stream it is currently in if it exceeds the limit value. All alarm types can be configured to trigger specific relays and/or outputs. To enable specific outputs for each alarm, simply put a checkmark in the desired checkboxes in the *Actions* box.

5.7 Archive Tab

5.7.1 The Table Format

The *Archive* tab presents data related to the analyzer's operation, including live concentration data, hourly averages, and other important data. When this screen is first accessed, an empty screen is presented (Figure 5-10).

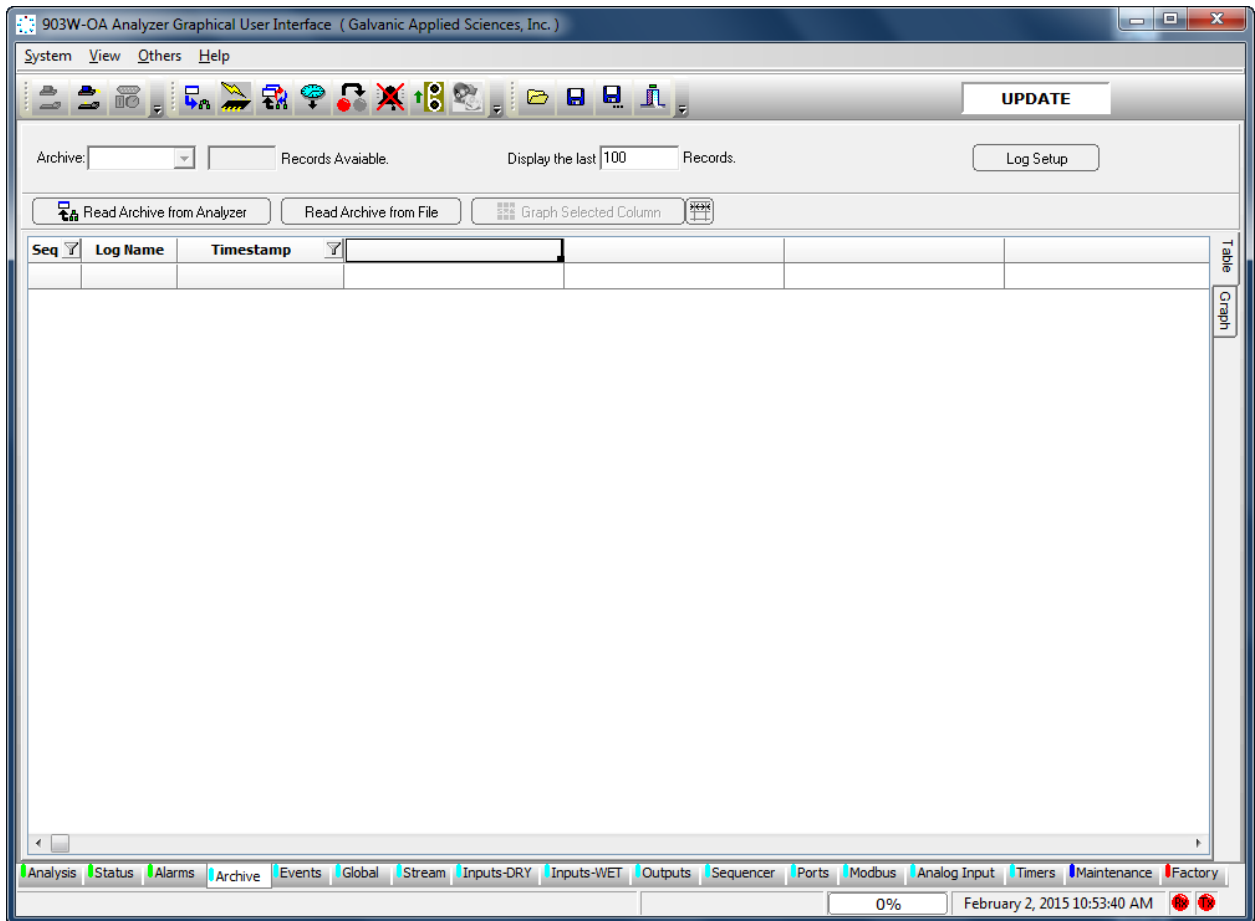

Figure 5-10: Archive Tab

To download archival data, press *the Read Archive from Analyzer* button. As an alternative, a previously saved archival record can be loaded by pressing the *Read Archive from File* button.

NOTICE

The archive on the analyzer is quite large, so downloading data from the archive can take several minutes, especially if the computer is connected to the analyzer via a serial connection. Once the data has been retrieved, the user will be prompted to choose a directory and a file name for the archive data to be saved to. If it is not necessary to save the archive data, press *Cancel* in the *Save File* dialog box. The archive data will not be saved but it can still be viewed and exported.

The *Archive* field at the top left of the screen includes a pull down menu which allows the user to select which archive should be viewed. The field immediately to the right of this menu shows how many records are stored in the currently selected archive. To retrieve data from this archive, enter a value in the *Display the last _____ Records* field and press the *Enter* key on the keyboard. This will pull up the number of records entered in the field, as shown in Figure 5-11.

Seq	Log Name	Timestamp	Live							
11424	On Run	10/08/2007 09:32:53	-0.0186478							
11425	On Run	10/08/2007 09:36:00	1.44170868							
11426	On Run	10/08/2007 09:39:08	0.30974787							
11427	On Run	10/08/2007 09:42:15	0.00294764							
11428	On Run	10/08/2007 09:45:22	0.39558964							
11429	On Run	10/08/2007 09:48:30	-0.0138876							
11430	On Run	10/08/2007 09:51:37	-7.8469514							
11431	On Run	10/08/2007 09:54:44	-0.0403111							
11432	On Run	10/08/2007 09:57:52	0.49382102							
11433	On Run	10/08/2007 10:00:59	-0.0122553							
11434	On Run	10/08/2007 10:04:06	-0.0308933							
11435	On Run	10/08/2007 10:07:14	-0.0139358							
11436	On Run	10/08/2007 10:10:21	-0.0293199							
11437	On Run	10/08/2007 10:13:28	0.00856544							
11438	On Run	10/08/2007 10:16:35	1.87335240							

Figure 5-11: Archive Window - Data Displayed

- *Seq* - identifies each data point in a sequential manner.
- *Log Name* - indicates which log the data came from. This is useful when the data is exported (Section 5.7.3.3). To look at another log, select the desired log from the pull down menu adjacent to the Archive indicia. For more information on the various types of logs, see Section 5.7.3.3.
- *Timestamp* - shows the date and time when the data in a given row was obtained. To the right of these grey columns are several white columns containing data. The first row in the archive has data labels that identify exactly what data is in each column. The column widths can be automatically scaled to fit the data by pressing the Auto-Size Columns () button at the top of the screen. The archive is set up at the factory to log the data points of the most interest to operators, though the archive is fully configurable to log many more data points – see section 0.

5.7.2 The Graph Format

The data in the white columns can be graphed by right clicking and dragging down to select the desired portion of a given data column. Once the data of interest has been selected, click on the *Graph Selected* button at the top of the screen. This will create a graph that shows the trend in the selected data (e.g. Figure 5-12).

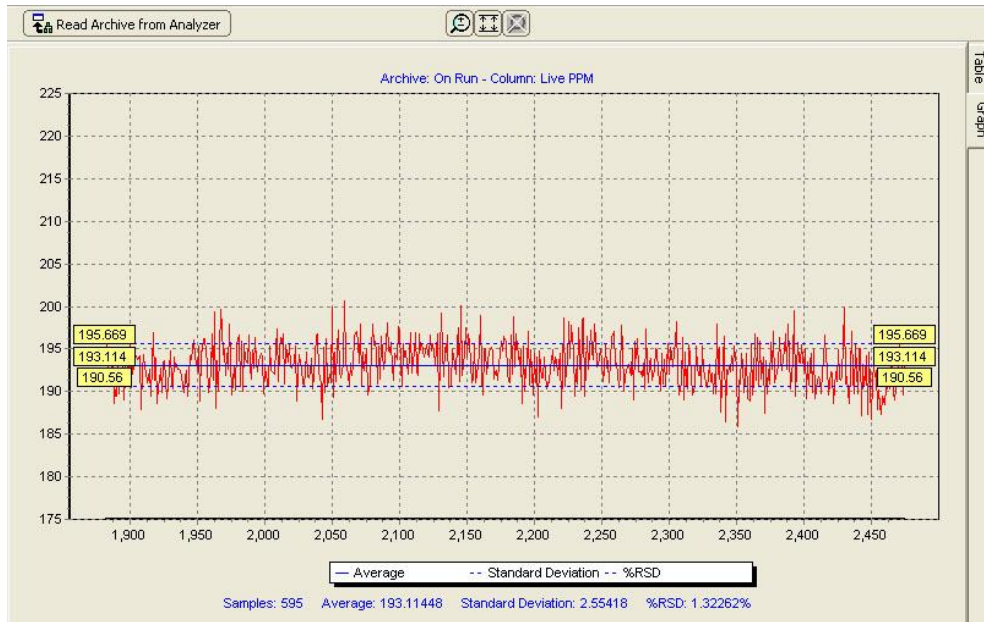

Figure 5-12: Charted Data

There are 3 blue dashed lines on the graph:

- The solid blue line in the middle shows the average of the selected data,
- The 2 dashed blue lines above and below the central line show one standard deviation away from the mean in both directions.



The yellow boxes at either end of the plot adjacent to solid blue line contain the numerical value of the average.

The yellow boxes at either end of the plot adjacent to the dashed blue line above the average contain the numerical value of the average plus 1 standard deviation, and the yellow boxes at either end of the plot adjacent to the dashed blue line below the average contain the numerical value of the average minus 1 standard deviation.

The numerical values of the statistics presented below the chart include the number of data points (samples), the average, the standard deviation, and the standard deviation, in percent, relative to the average.

The three buttons on the chart window are described in Table 5-7.

Table 5-7: Chart Button Functions

Button	Name	Function
	Zoom Mode	Toggles Zoom mode on and off. When the button is clicked, left clicking on the chart will zoom in on a section of the chart, centered on the clicked location. Right clicking will zoom out on a section of the chart, again centered on the clicked location. When zoomed in on the data, the user can scroll left, right, up and down using the arrow keys on the computer keyboard.
	Auto-Scale	Automatically adjusts the y-axis scale so that all data within the zoomed in selection can be seen.
	Show Entire Graph	Cancels all zooms and returns to the auto-scaled graph originally produced when the data was first graphed.

A pop-up menu with the functions indicated in Table 5-8 can be accessed by right clicking on the chart.

Table 5-8: Chart Manipulation Options

Menu Option	Sub-options	Function
Set Scale	Scale to Data	Scales the y-axis to the data. This is the default scaling when a graph is first made.
	Scale Manually	Brings up a dialog box that allows the user to set the minimum and maximum value for the y-axis scale.
Print	N/A	Prints the chart to the printer of the user's choice
Copy to Clipboard	N/A	Copies the chart to the clipboard as an image to allow the user to paste it into another application, such as Microsoft® Word™
Preferences	Set Trace Colour	Allows the user to set the colours used for both the data and the statistics lines on the chart.
	Set Background Colour	Allows the user to set the chart's background colour.
	Reset Default Colours	Resets all colours to their defaults: red for data, blue for statistics, and grey for the background.
	Invert Scrolling	When this option is selected, inverts the function of the arrow keys while zoomed in on data (i.e. down key moves up, left moves right, etc).
	Print Orientation	Allows the operator to select whether the chart will be printed in landscape or portrait mode. The default is landscape.
	Print Sizing	Allows the operator to select whether the printed chart will be scaled to fit the selected size of paper, or kept in the on-screen proportions. The default is scaled to fit.
	Show Statistics	Toggles statistics labels on the chart on and off. The default is on.

5.7.3 Filtering Data

The data table can be filtered to show only certain data by clicking on the funnel (🔍) icon in the header in any column (except the *Log Name* column). Data can be filtered by date in the timestamp column, and by using one of six numerical operators in any column containing numerical data. The two types of filtering will be covered separately.

5.7.3.1 Filtering Data by Date

Clicking on the funnel icon on the right hand side of the *Timestamp* column header will present a pull-down menu that contains the following options:

- *All* - Selecting All will turn off any current filtering of data by date.
- *Custom* - Selecting Custom will bring up the dialog box shown in Figure 5-13.



Figure 5-13: Date Sorting Selection Dialog Box

The dialog box allows the user to choose a date range for the data that they wish to display, starting at a certain date and ending at a certain date.

- *Today* - shows only data obtained on the current date.
- *Yesterday* - shows only data obtained yesterday.
- *This Month* - shows only data obtained in the current month.
- *Last Month* - shows only data obtained in the previous month.

NOTICE

The date and time must be correctly set on the analyzer for this filtering to work correctly, as the timestamp on each row of data is obtained from the analyzer's internal clock.

5.7.3.2 Filtering Data Numerically

In the header of the column to be filtered, clicking on the funnel icon on the right hand side of the header will cause a pull down menu to appear. The menu contains the options *All* and *Custom*. As before, selecting *All* will cause any current numerical filtering of data to be cleared. Selecting *Custom* will bring up the dialogue box shown in Figure 5-14.

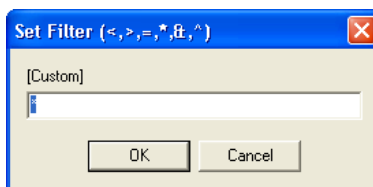

Figure 5-14: Custom Numerical Filtering Dialog Box

NOTICE

This method of filtering works best in the sequence number column, although it can be used in any column that contains numerical data.

Six numerical operators can be used to filter the data (Table 5-9).

Table 5-9: Data Sorting Operators

Operator	Name	Function
>	Greater Than	When this operator is used in conjunction with a number, the data will be filtered such that only data greater in value than the number entered will be displayed. For example, if the expression ">1000" was entered into the dialog box, the column will be filtered such that only data with values greater than 1000 will be displayed.
<	Less Than	When this operator is used in conjunction with a number, the data will be filtered such that only data lower in value than the number entered will be displayed. For example, if "<1000" was entered into the dialog box, the column will be filtered such that only data with values less than 1000 will be displayed.
=	Equal to.	When this operator is used in conjunction with a number, the data will be filtered such that only data that is EXACTLY equal to the number entered will be displayed. For example, if "=1000" was entered into the dialog box, only data exactly equal to 1000 will be displayed.
*	Ending Digits	When this operator is used in conjunction with a number, the data will be filtered such that only data ending in the number entered will be displayed. For example, if "*25" was entered, the column will be filtered such that only data ending in 25 (e.g. 9.2929292925, 1.00000025, etc) will be displayed.
^	And	When this operator is used to join a string of numbers together, the data will be filtered such that only data being exactly equal to each number in the string will be displayed. For example, if the expression "1^5^7^12" was entered into a list of data containing the whole numbers from 1 to 20, the only numbers in the list that would pass through this filter would be the numbers 1, 5, 7, and 12.
&	Both functions fulfilled	When this operator is used to join two or more other operators in a string, the data will be filtered such that only data that fulfills all of the operators' conditions will be displayed. For example, if the user wished to display all of the data with values between 7 and 8, they could type ">7&<8" into the dialogue box. Note, of course, that this would filter out values of exactly 7 and exactly 8.

5.7.3.3 Exporting Data

A variety of data export formats are provided by the GUI. To access a list of formats, right click on the archive data table. The formats are listed below:

- *Load From File* - loads a previously saved proprietary data file (.dcar).
- *Save to File* - saves the data to a Galvanic proprietary format (.dcar).
- *Save as Packet CSV* - Saves the archive data for the displayed tab as a CSV file.
- *Save as Legal CSV* - Saves the archive data for all tabs as a CSV file.
- *Save as XLS* - saves the data to a Microsoft Excel File
- *Copy Selection to Clipboard* - allows the user to copy a selection from the data table to the clipboard to be pasted into another program (e.g. Microsoft Excel).
- *Copy Image to Clipboard* - copies an image of the table to the clipboard that can be pasted into an image-editing program or into a Microsoft Word document.
- *Hide Selected Column(s)* - hides one or more selected columns. If a table is exported to a Microsoft Excel file while columns are hidden, those hidden columns will NOT be exported to the file.
- *Unhide All Columns* - displays any columns of data that may have been previously hidden.

5.7.3.4 Log Setup

If desired, the analyst can format the log in a different manner than the default log (Figure 5-10). To configure the analyzer to log values in data points other than those set up at the factory, press the *Log Setup* button at the top of the *Archive* tab to present the *Log Configuration* dialog box (Figure 5-15).

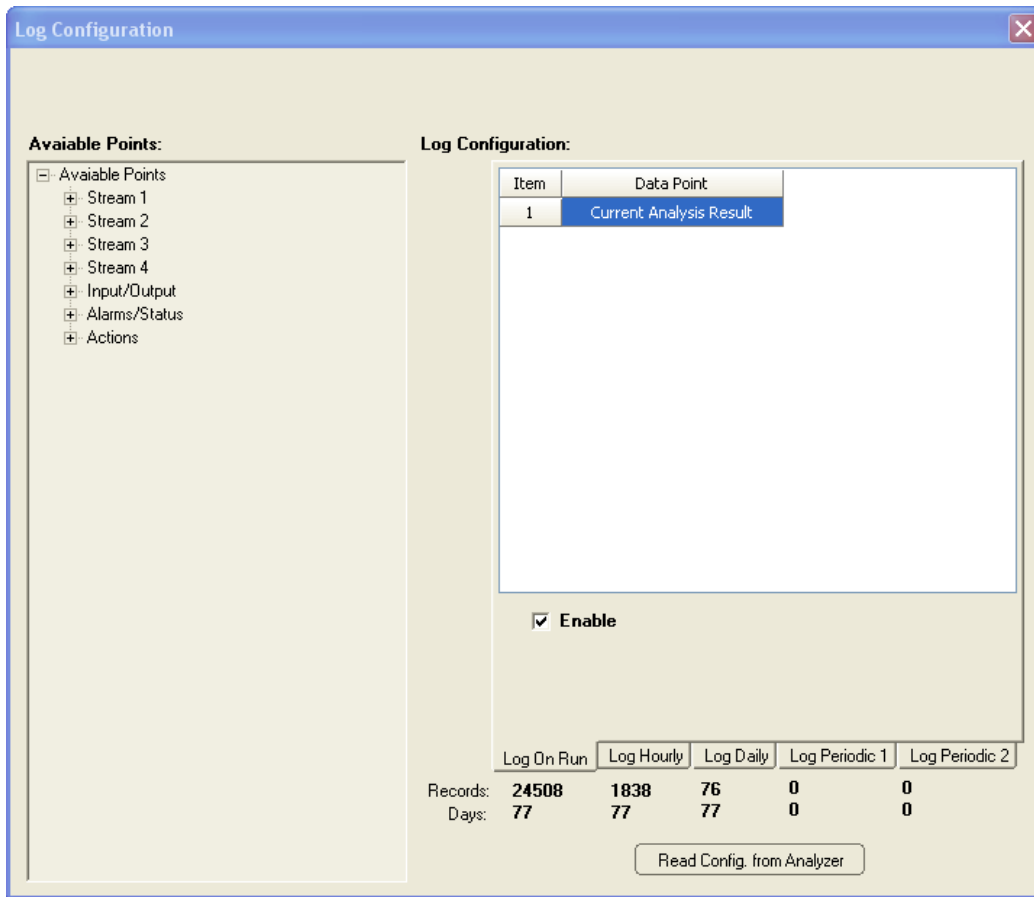

Figure 5-15: Archive Setup Window

The following six log formats are available:

- *Log On Run* - the values of the data points logged in this log will update after every completed analysis cycle.
- *Log Hourly* - the hourly average of the data points logged in this log will update every hour. The log is updated at the top of every hour.
- *Log Daily* - the daily average of the data points logged in this log will update every day. The time at which the log is updated can be set in the 'Hour Taken' column. The log can only be updated at the top of the hour. Enter a value of 0 (midnight) to 23 (11pm) in this column.
- *Log Periodic 1 and 2* - these two logs are empty by default when the analyzer is set up at the factory. Any data point of the user's choosing can be logged in each of these three logs, at a frequency of the user's choosing. The frequency of logging, in seconds, is entered into the column entitled *Frequency (Seconds)*. Please note that the frequency of logging for each data point within a given periodic log must be the same; that is to say, if one data point in Log Periodic 1 has a logging frequency of 1000 seconds, all the data points in Log Periodic 1 will have a logging frequency of 1000 seconds.

The tree on the left side of the *Log Configuration On* dialog box contains 7 nodes. Within each of these nodes are data points that can be logged. Many of these data points are static or rarely changed values that should not need to be continuously logged. The data points of the most interest are stored in the two nodes called *Input/Output* and *Alarm/Status*.

- *Input/Output* contain data points such as the current concentration readings for all stream types (normal, calibration, reference, and zero), the gain, status of various alarms and latches, and the status of discrete inputs and outputs.
- *Alarm/Status* contains data points such as the live sensor output, hourly and daily minima, maxima, and averages, and the tape remaining.

To expand any node, simply left click on the (+) icon to the left of the node label. This will expand the node to show all of the data points within that node. To put any data point into a log, left click on the data point of interest, and while holding the right mouse button down, drag the data point into the desired log. Once the left mouse button has been released, the data point should become a row in the table for the log, and the change to the log configuration will be automatically written to the analyzer. If the data point is in Log Periodic 1-3, ensure that a frequency is entered for the data point.

NOTICE

Changing the frequency time within a given periodic log will cause all the frequency times in that log to change to the same value.

To remove a data point from any log configuration, simply right click on the row to be removed, and then select the *Delete Item* option from the popup menu that appears. Once all the desired changes are made, click on *Read from Unit* to ensure that the changes have correctly written to the unit, and then click on the X in the top right hand corner to close the *Log Configuration* window.

5.8 Events Tab

The *Events* tab (Figure 5-16) contains a list of all of the various conditions (alarms, power on/off, configuration changes, discrete input conditions, etc. that occur as the analyzer runs and is primarily used as a troubleshooting aid. The *Event Log* may be very useful in tracking down the source of a problem with the system.

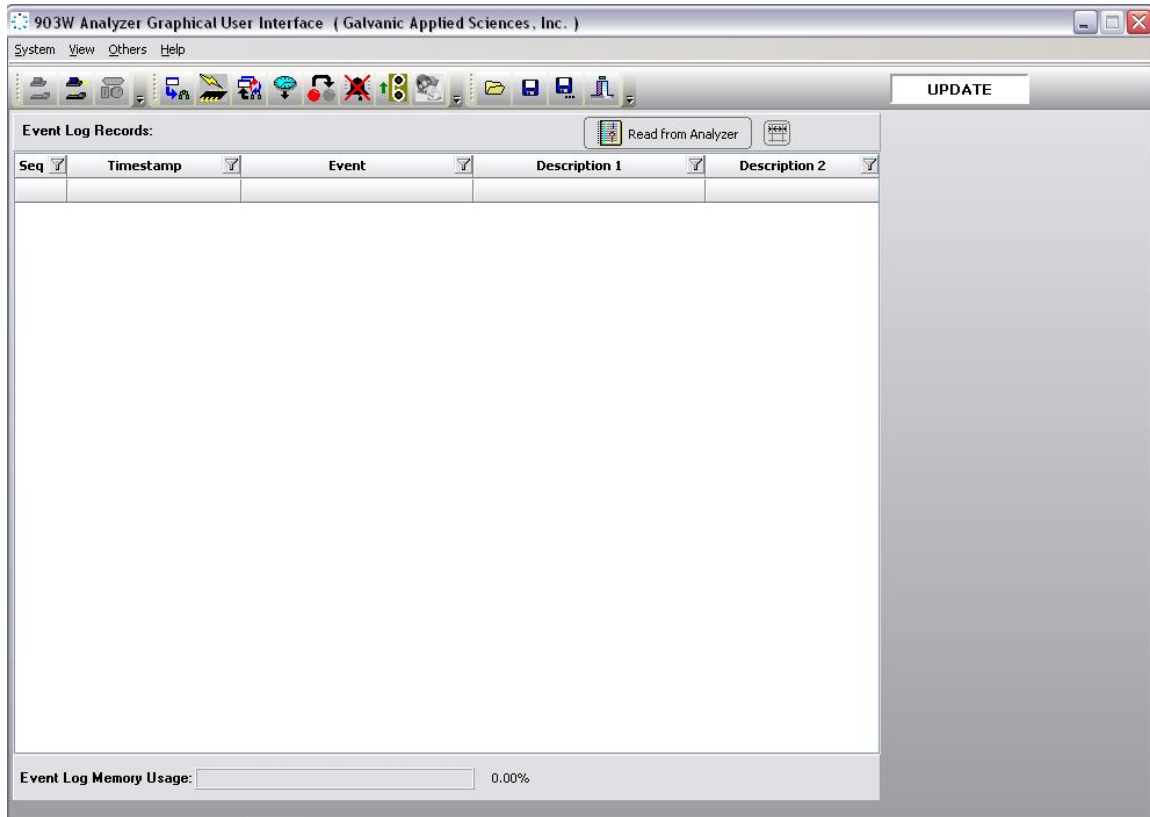

Figure 5-16: Events Tab

In addition, the *Event Log* maintains a record of the types of alarms that have occurred during operation of the analyzer and the time when the alarm was sent. To obtain a full list of all of the *Event Log* records from the analyzer, simply press the *Read from Device* button at the top of the screen.

Records in the Event Log can be sorted according to the date, using the same procedure which was described in Section 5.7 for the *Archive* tab. Since the *Event Log* does not contain numerical data, numerical sorting is not possible, but it is possible to sort it according to the type of event that caused data to be recorded. As an example, if the user wished to show all the alarms that had been triggered in the system since it began operating, it is possible to filter the event column using the parameter =*Alarm*. This will show all alarms stored in the *Event Log*. The *Event Log* also changes in configuration and power up events.

At the bottom of the screen is a bar graph titled *Event Log Memory Usage*. This shows the percentage of the Event Log memory currently used by the Event Log. When this number reaches 100%, the analyzer will start writing over the oldest Event Log records with the newest records. An example of the *Event Log* window is shown in Figure 5-17.

Event Log Records:					Read from Analyzer
Seq	Timestamp	Event	Alarm	State	
1	23/03/2007 15:00:41	Power Up	No Alarm	Condition On	
2	23/03/2007 15:06:48	Alarm	Sensor LED Current	Condition On	
3	23/03/2007 15:14:00	Power Up	No Alarm	Condition On	
4	23/03/2007 15:19:17	Power Up	No Alarm	Condition On	
5	23/03/2007 15:31:54	Power Up	No Alarm	Condition On	
6	23/03/2007 16:07:01	Power Up	No Alarm	Condition On	
7	26/03/2007 09:13:26	Alarm	Stream 1 PAA	Condition On	
8	26/03/2007 09:14:31	Alarm	Stream 1 PAA	Condition Off	
9	26/03/2007 09:20:21	Power Up	No Alarm	Condition On	
10	26/03/2007 10:18:31	Configuration Changed	No Alarm	Condition On	
11	26/03/2007 10:26:31	Configuration Changed	No Alarm	Condition On	
12	26/03/2007 10:27:51	Configuration Changed	No Alarm	Condition On	
13	26/03/2007 10:28:34	Alarm	Stream 1 PAA	Condition On	
14	26/03/2007 10:29:53	Alarm	Stream 1 PAA	Condition Off	
15	26/03/2007 10:29:55	Configuration Changed	No Alarm	Condition On	
16	26/03/2007 10:36:34	Alarm	Stream 1 Normal Alarm 1	Condition On	
17	26/03/2007 10:37:54	Configuration Changed	No Alarm	Condition On	
18	26/03/2007 10:38:54	Alarm	Stream 1 Normal Alarm 1	Condition Off	
19	26/03/2007 11:06:47	Alarm	Stream 1 Normal Alarm 1	Condition On	
20	26/03/2007 11:32:58	Alarm	Stream 1 Normal Alarm 1	Condition Off	
21	26/03/2007 11:32:58	Configuration Changed	No Alarm	Condition On	
22	26/03/2007 12:08:29	Configuration Changed	No Alarm	Condition On	

Event Log Memory Usage: 0.25%

Figure 5-17: Event Log

5.9 Global Tab

The *Global* tab (Figure 5-18) includes a broad range of parameters that impact the overall operation of the analyzer. In addition, it is used to assign various alarms to the appropriate relays and solenoids. The Global screen is divided into three areas:

- General (Section 5.9.1)
- Global Alarms (Section 5.9.2)
- Calibration Gain Calculator (Section 5.9.3)

NOTICE

Whenever any change is made to a changeable field, the change must be written to the analyzer before leaving that page by pressing the *Temporary*

Write To Analyzer button . It is not necessary to write after every change, but all changes **MUST** be written before leaving the tab. It is also a

good idea to execute a *Permanent Configuration Write*  to the analyzer or any changes made will be lost if the analyzer is a powered down.

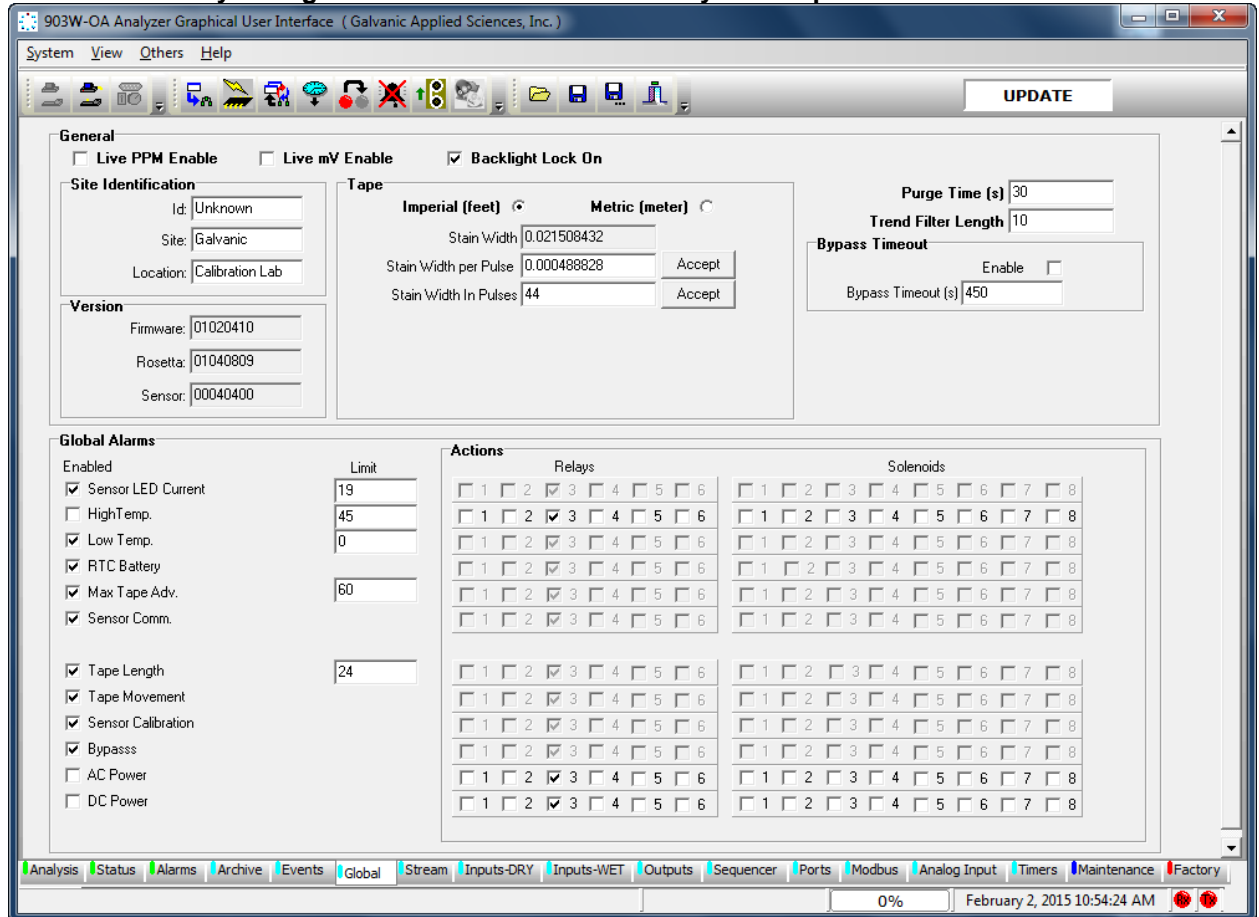

Figure 5-18: Global Tab

5.9.1 General

The *General* box contains fields that affect the overall configuration of the analyzer.

- *Live PPM Enable* - If a checkmark is placed in this box, the analyzer's LCD screen will update the gas concentration as it is calculated within the analyzer on a live basis. When this checkbox is left un-checked, the screen will only update with a new concentration value when an analysis cycle has completed.
- If Live PPM is enabled, the concentration units displayed on the LCD screen will have an L in front of them (i.e. if the concentration units are PPM, then the screen will read LPPM if Live PPM is enabled).
- *Live mV Enable* - If a checkmark is placed in this box, the analyzer's LCD screen will show the raw sensor output, counting down from approximately 1000mV, rather than the sensor output that is adjusted to count up from 0mV. If the Live mV is enabled, the units of the sensor output displayed on the unit's LCD screen will change from mV to LmV.
- *Backlight Lock On* - The LCD on the analyzer has a backlight that causes the screen to light up and be easier to read. If this checkbox is checked, the backlight on the screen will be continuously turned on. This should only be checked if power consumption on the analyzer is not a serious concern.
- *Site Identification* - This box contains three fields that contain the unit's unique identification. The *ID* field contains the analyzer's serial number. The *Site* field tells the operator which site the analyzer is installed at, and the *Location* field tells the operator where in the site the analyzer is installed. Do not change the ID field under any circumstances unless instructed to by Galvanic service personnel.
- *Version* - The values in the three unchangeable fields in this box show the current versions of firmware installed in the analyzer, the sensor block, and the Rosetta that helps the GUI identify the data it reads from the analyzer. These values are useful for diagnosing problems.
- *Bypass Timeout* - Bypass mode disables any outputs that may be triggered by alarms and is normally used when service is being performed to avoid inadvertent triggering of alarms. For normal operation, it is essential that bypass mode be disabled.

The analyzer is equipped with a bypass timeout. When enabled, by putting a checkmark in the Enable box, bypass mode will automatically be exited by the analyzer after a certain number of seconds after the last keypad button push. The length of the bypass timeout, in seconds, can be set by the user in the *Bypass Timeout(s)* field. By default, this is set to 450 seconds, and is disabled. When the analyzer is in bypass mode, the output from both analog outputs goes to the fail-safe output to ensure that the user recognizes that the analyzer is in bypass mode.

- *Trend Filter Length* - This field determines the weighting the current reading has in the calculation of the historical trend. The larger this number is, the smaller the weighting the current value has in the calculation of the historical trend. The trend is a form of data filtering that smoothes the long-term data to show a long-term trend in concentration. This value should not be changed except after consultation with the Galvanic Applied Sciences service department.
- *Purge Time* - This field determines the length of time the analyzer should be purged after a stream switch. When a stream switch occurs, the analyzer will advance the tape, then

purge with the new gas for as many seconds as the number in this field, then advance the tape again before starting to analyze the new stream. The longer this number is, the better the results will be on the next stream. A minimum time in this field should be about 30 seconds.

5.9.1.1 Tape Field

The *Imperial (Feet)* and *Metric (Meter)* radio buttons are used to indicate the units used for the tape box. Selecting between the two does not recalculate any numbers in the *Tape* box – these two buttons are simply used to allow the user to see at a glance what units the numbers in the *Tape* box are in. By default, the analyzer is set up to use imperial units for tape.

- *Stain Width* - shows the width, in feet or meters of a single stain on the tape. This field is calculated based on values in the next two fields.
- *Stain Width per Pulse* - shows the distance that the tape advances every time the pulse counter receives a pulse.

The calculation of *Stain Width per Pulse* is typically performed only if the pulley on the pulse counter needs to be replaced.

To calculate the value:

- a) Measure the diameter, in inches, of the pulse counter pulley using a set of calipers.
- b) Multiply this number by π to get the circumference of the pulley; then divide the result by 12 to get the circumference of the pulley in feet.
- c) The Pulse Counter receives 256 pulses every time it makes one full revolution, so dividing the circumference of the pulley in feet by the number of pulses per revolution will give the length of tape advanced when the pulse counter receives one pulse. This is expressed in the following formula:

$$\text{Stain Width per Pulse (feet)} = ((\text{Diameter}_{(\text{inches})} \times \pi) / 12) / 256$$

The formula can also be expressed in metric format as follows:

$$\text{Stain Width per Pulse (meters)} = ((\text{Diameter}_{(\text{millimeters})} \times \pi) / 1000) / 256$$

If a metric value is entered into this field, the value in the *Stain Width* field will also be in metric format. When the *Accept* button is pressed, the value in the *Stain Width* field will be recalculated.

The *Stain Width In Pulses* field allows the operator to choose how many pulses the pulse counter should receive before stopping a tape advance. The larger the number in this field, the greater the stain spacing will be. The smaller the number in this field, the more overlap there will be between stains. By default, this number is set to around 40. If the spacing is too great with a value of 40, reduce this number to around 37 and check stain spacing again. Too much overlap between subsequent stains will cause poor results. Too much white space between subsequent stains will cause faster than desired tape usage. The maximum value that can be entered into this field is 99. If the user enters a value higher than this into the field and attempts to write it to the analyzer, the field will turn yellow, indicating that an invalid value has been entered. Enter a value between 1 and 99 into this field and then press the *Accept* button.

The *Tape Remaining (days)* field is calculated using the stain width information described above to show the amount of tape remaining on the reel, in days. This value can be calculated by hitting the calculate button. Another useful calculator is the *Tape Remaining After Tape alarm (days)*. By pushing this field's *Calculate* button the operator can see exactly how many days of tape life there is after the Tape Length alarm.

NOTICE

It is **ESSENTIAL** that tape length is updated every time one is replaced. For example, if the user is using a 330 foot sensing tape, it is essential that this field be updated to a value of 330 every time a new tape is installed.

5.9.2 Global Alarms

12 analyzer global alarms can be enabled or disabled. Out of the 12 alarms, 5 have editable *Limit* fields.

- *Sensor LED current alarm limit* is set by default to 19mA for a Class I, Div. 2 unit. The actual sensor LED current can be viewed on the *Analysis* tab.
- *High and Low temperature limits* are set to 40°C and 0°C respectively.
- *Maximum Tape Advance Limit* is set to 60 seconds. The actual tape advance time will vary depending on the darkness of the tape staining.
- *Tape Length Limit* field is set to 20 ft. If the analyzer calculates the tape length to be less than the limit, an alarm will be set.

Each global alarm has a list of relays and solenoids that can be used to activate an alarm action response. To change any of these actions from the default setting, the global alarm needs to be disabled first (remove the checkmark from its corresponding checkbox by a left mouse click). Once this is done, choose the desired action by placing a checkmark into the appropriate actions checkbox and then re-enable the global alarm.

5.9.3 Calibration Gain Calculator

The *Calibration Gain Calculator* can be used to calculate what the new Gain Factor will be when performing a manual calibration.

5.10 Streams Tab

5.10.1 Overview

The *Streams* tab (Figure 5-19) is used to configure the analyzer to perform the desired analyses.

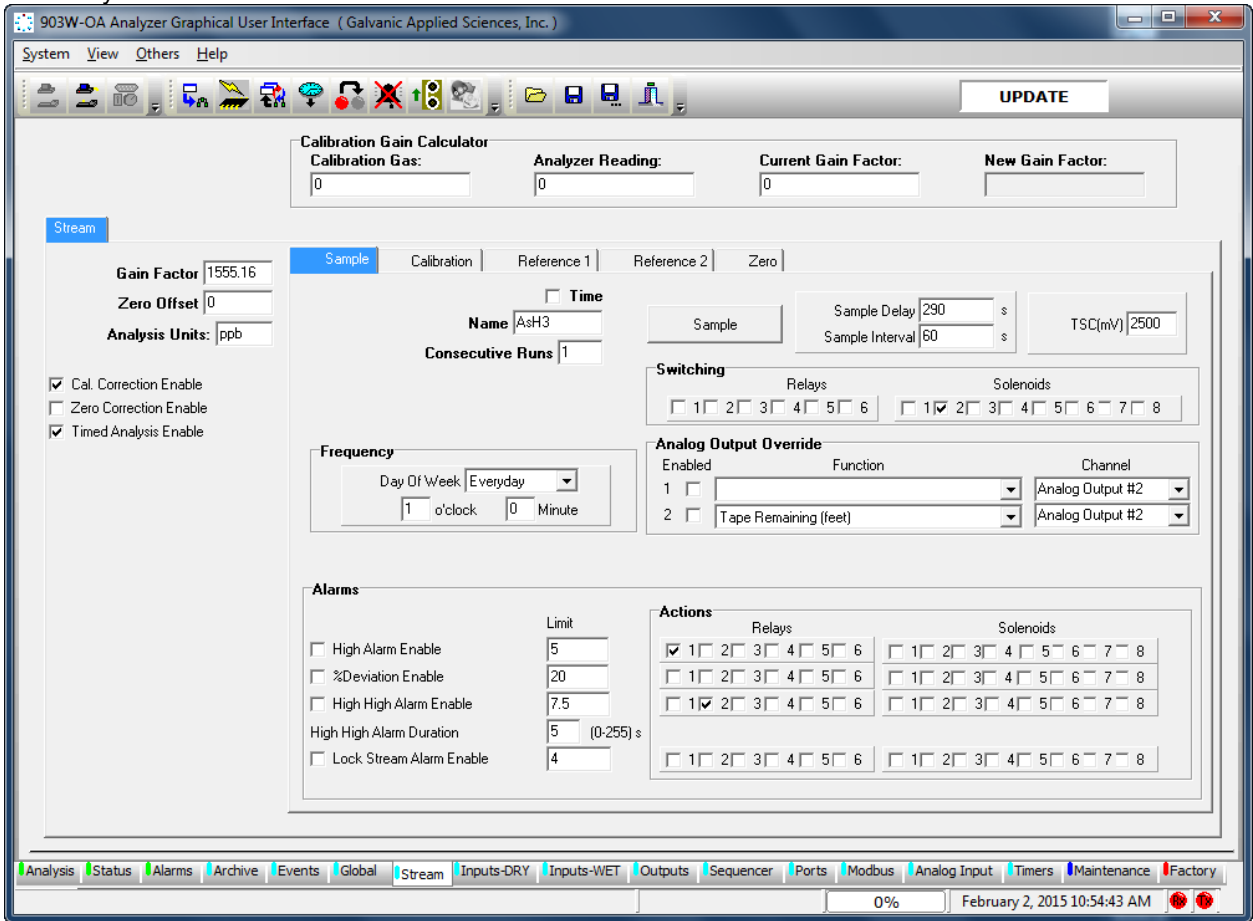

Figure 5-19: Stream Tab - Sample Tab

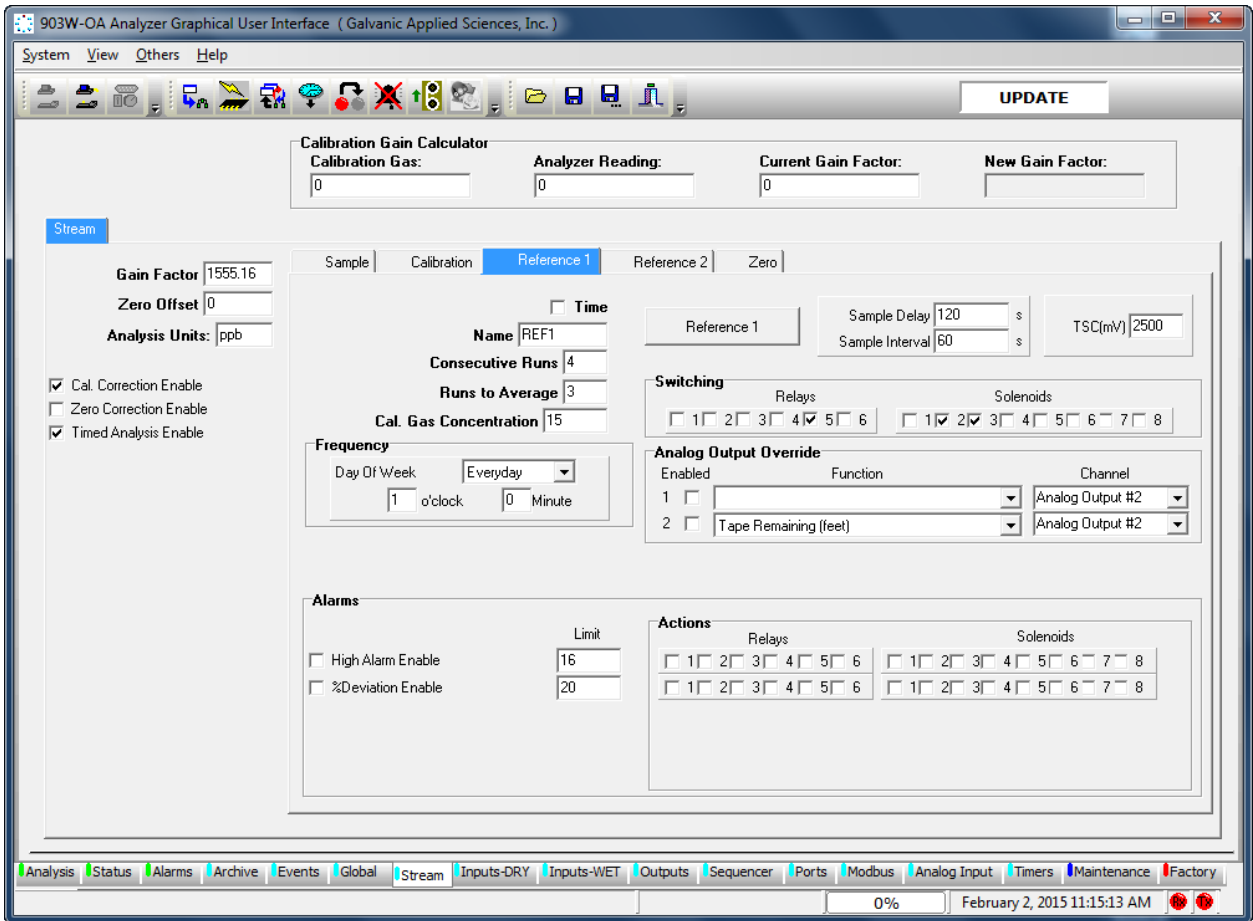

Figure 5-20: Stream Tab - Reference Tab

The *Stream Number* and *Gas Type* tabs are highlighted to identify that the stream/gas type for which parameters are being edited (i.e. in Figure 5-19, parameters for Sample for stream 1 is being edited). The system described in Figure 5-19 and 5-20 includes screens which can be edited.

The three parameters and three check boxes on the left of the tab are universal; when an entry is made on one screen, the value/setting will be employed for all tabs for that stream. All other parameters are independent parameters and can be different for the various gases relative to that stream.

5.10.2 Universal Gas Run Commands

The three parameters and three check boxes on the left side of each stream tab refer to all of the gas runs types for that particular stream:

- *Gain Factor* - the parameter that relates the rate of stain on the tape to an actual concentration. This value is determined during analyzer calibration with a known standard.
- *Zero Offset* - the value that is subtracted from all concentration readings to give corrected readings. Zero offset is obtained by running the 'Zero' stream, which is usually run on a gas that contains no chlorine, such as pure nitrogen.
- *Analysis Units* field - allows the user to change the units that are displayed on the screen. This can be PPM, PPB, Mol%, or any other unit the user chooses. Please note that changing the value in this field does NOT change the calibration of the analyzer - if the user wishes to change the calibration of the unit to be in a different unit, they must use a calibration gas with a known concentration in the unit they wish to display.
- *Cal. Correction Enable* check box - used to indicate that the calibration run is used to change the gain factor. If this box is not checked, then the calibration run is essentially another reference run.
- *Zero Correction Enable* check box - used to indicate if the zero gas run to change the zero offset. If this box is not checked off then the zero run is essentially another reference run.
- *Timed Analysis Enable* check box - used to indicate that the Peak Detect method of analysis should be disabled and Timed Analysis method should be enabled. The method of analysis used is determined by the application requirements and set at the factory.

5.10.3 The Sample Tab

The *Sample* tab is used to enter relevant information about the analysis of these gases. The tabs include the common gas run parameters described in Section 5.10.2 and the following parameters and settings.

5.10.3.1 Timing Commands

The *Timing* commands (Figure 5-21) relate to various timing issues and miscellaneous issues that relate to operation of the system.

The screenshot shows a control panel for timing commands. It includes a 'Time' checkbox, a 'Name' text field, a 'Consecutive Runs' text field, a 'Stream 1 Sample' button, 'Sample Delay' and 'Sample Interval' text fields with units, and a 'TSC(mV)' text field.

Figure 5-21: Timing Commands

- *Time Check Box* - When the *Time* check box is checked, the operator can perform a run as defined by the Frequency section of the gas run type tab below. If the Time check box is not checked, the gas run will not start without being configured in the Sequence or Timers Tabs or a via a manual initiation by clicking on the gas run type button such as the *Sample* button.
- *Stream 1 Sample* - Initiates a run using the indicated parameters.

- *Sample Delay and Sample Interval* - The sample delay time and sample interval time added together make the total analysis cycle time. The sample delay and sample interval are used differently depending on which analysis algorithm is in use; the standard (peak detection) algorithm of the fixed time analysis algorithm.
- *Standard Analysis*: In the standard analysis algorithm, the software detects the point during the analysis where the rate of stain reaches a maximum value. At this point the concentration of chlorine is calculated and stored until either the end of the cycle or a different maximum value is detected. During the sample delay time the analyzer will not search for the maximum rate of stain. The sample delay time is used to ignore the first part of the analysis cycle where noise due to the tape advance may be present. The sample delay will typically be 10 seconds. During the sample interval, the analyzer will be allowed to search for the rate of stain maximum value. The sample interval will typically be 230 seconds to give a typical cycle time of 240 seconds.
- *Fixed Time Analysis*: In the fixed time analysis algorithm, the analyzer calculates the average rate of stain over a fixed period of time, called the sample interval. The analyzer will not calculate the average rate of stain during the sample delay because the rate of stain is generally not stable during this time period. Typically the sample delay is approximately 120 to 180 seconds for the fixed time analysis and the sample interval is approximately 30 – 60 seconds to give a total cycle time of 3 to 4 minutes.

The type of analysis algorithm used will depend on the analyzer's specific application and is set up at the factory. The type of algorithm used and the sample delay and interval values should not be changed without consulting the Galvanic Applied Sciences.

- *Tape Saturation Cut-off (TSC)* - The *tape saturation cut-off* is the sensor output at which the analyzer will automatically cease the current analysis, calculate the concentration value for the current analysis, update all outputs, advance the tape, recalibrate the sensor block, and begin a new analysis cycle. The TSC takes precedence over the sample interval time for completion of an analysis - that is to say, if the sensor output reaches the TSC prior to the completion of the sample interval time, the analysis will be considered to be complete. Thus, the sum of the sample delay and sample interval times in the standard analysis mode is only a maximum cycle time value and the actual cycle time could potentially be shorter. To have a better chance of the maximum cycle time being the actual cycle time, the TSC value should be set to a very high value in the GUI (a large value is set at the factory). Setting the TSC value to a high level makes it much more likely that the analysis time will reach the end of the sample interval prior to reaching the TSC.
- *Name Field* – used to enter the name that will be displayed in the *Current Analysis* field in the *Analysis* tab. It will also be displayed on the analyzer LCD screen when the run types are displayed under the F1 STRM menu.
- *Consecutive Runs* - indicates how many times to run the Gas run before switching to the next run in the run queue. If no other run is enabled and it is set up in the Automatic Sequence under the sequence tab, the analyzer will simply continue running until another run is triggered either conditionally or scheduled.

5.10.3.2 Switching Field

The *Switching* field (Figure 5-22) allows the user to configure what relays and or solenoids are associated with each of the gas run types that are being used. There are 6 relays and 8 solenoids that can be controlled by the analyzer. Putting a checkmark in any of the relay or solenoid boxes will cause that relay or solenoid to energize when one of the analysis modes is running.



The image shows a control panel titled "Switching". It is divided into two sections: "Relays" and "Solenoids". Under "Relays", there are six checkboxes labeled 1 through 6. Under "Solenoids", there are eight checkboxes labeled 1 through 8. All checkboxes are currently unchecked.

Figure 5-22: The Switching Field

5.10.3.3 Frequency

If the *Time* check box is checked (see Section 5.10.3.1) the operator can schedule the gas run as per set in the Frequency section (Figure 5-23) of the gas run type tab. The drop down Day of Week list includes Everyday and each day (Sunday to Saturday).



The image shows a control panel titled "Frequency". It contains a "Day Of Week" dropdown menu set to "Everyday". Below it, there are two input fields: "1" for hours and "0" for minutes, with labels "o'clock" and "Minute" respectively.

Figure 5-23: The Frequency Field

5.10.3.4 Analog Output Override

If an *Analog Output Override* is enabled (Figure 5-24), the user can set up two analog channels for each of the gas run types that will override the default analog outputs set on the *Outputs* Tab. An example of this would be to set the *Function* of analog output *Channel 1* to *Stream 1 Calibration* if the default was set up as "Stream 1 Sample". This would allow Analog Output 1 to be used for both Stream 1 Sample Reading and Calibration Reading. The Function dropdown list includes stream readings and a variety of other parameters and the Channel list includes all six analog outputs.

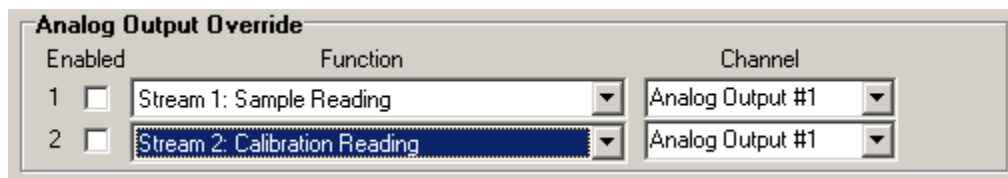

The image shows a control panel titled "Analog Output Override". It has a table with three columns: "Enabled", "Function", and "Channel".

Enabled	Function	Channel
1 <input type="checkbox"/>	Stream 1: Sample Reading	Analog Output #1
2 <input type="checkbox"/>	Stream 2: Calibration Reading	Analog Output #1

Figure 5-24: Analog Output Field

5.10.3.5 Stream Calibration Used

This field allows the gain factor from one stream to be used on other streams..

5.10.3.6 Alarms

The *Alarms* field (Figure 5-25) is used to assign the alarms to the appropriate relay or solenoid and enter the level at which the alarm should be triggered. All alarm types can be configured to trigger specific relays and/or solenoids. To enable specific outputs for each alarm, simply put a checkmark in the desired checkboxes in the *Actions* box.

The screenshot shows the 'Alarms' configuration window. On the left, there are four rows of controls: 'High Alarm Enable' with a checked checkbox and a limit value of 16; '%Deviation Enable' with an unchecked checkbox and a limit value of 20; 'High High Alarm Enable' with a checked checkbox and a limit value of 18; and 'High High Alarm Duration' with a value of 0 and a range of (0-255) s. Below these is 'Lock Stream Alarm Enable' with an unchecked checkbox and a value of 4. On the right, the 'Actions' section is divided into 'Relays' and 'Solenoids'. Each has three rows of checkboxes numbered 1 through 6 (for relays) and 1 through 8 (for solenoids). In the first row of Relays, checkbox 1 is checked. In the second row of Relays, checkbox 1 is checked. In the third row of Relays, checkbox 1 is checked.

Figure 5-25: Alarms Field

- *High Alarm Enable* - If this box is checked, then the limit value entered will be used as an alarm point. The *High Alarm* is an alarm that triggers when the calculated concentration at the end of a cycle is higher than the High Alarm set point. The High Alarm set point can be set either through keypad or through the GUI. The analyzer compares the final calculated concentration at the end of the sample interval with the alarm 1 set point value. If the value of the calculated concentration is higher than the alarm set point value, the alarm will be triggered, the alarm LED on the front panel will turn on, the event will be listed in the Event Log and on the Analyzer Alarm list on the analyzer LCD screen, and any outputs associated with this alarm will also be triggered. Once the concentration of the normal stream drops back below the Alarm 1 set point, the alarm LED will turn off, Alarm 1 will be cleared from the Analyzer Alarm List, and any unlatched outputs associated with Alarm 1 will return to their non-triggered state. Any latched outputs associated with this alarm will have to be manually cleared through the GUI.
- *% Deviation Enable* - If this box is checked, then the limit value entered will be used as an alarm point. This alarm will activate when consequent runs vary from each other by a greater percentage than the value set in the limit field. Deleted sentence.

- *High-High Alarm Enable* - If this box is checked then the limit value entered will be used as an alarm point. The High-High Alarm also known as the Predictive Alarm Analysis (PAA) alarm mode is an alarm mode that triggers when the live calculated concentration at any point during the analysis cycle (except for the sample delay on the standard analysis method) exceeds the High-High alarm set point. When the analyzer enters this PAA mode, the concentration displayed on the LCD screen immediately begins to update with the live concentration value once per second. In addition, any analog output or MODBUS register that is currently outputting the stream normal concentration value will also output the live value of the concentration once per second while the analyzer is in PAA mode.

When the analyzer is in PAA mode, this alarm will be listed in the Analyzer Alarm list, as well as in the Event Log, and the red ALARM LED on the front panel of the analyzer will also be lit. Any outputs associated with this alarm mode will also be triggered. Once the concentration of the normal stream drops back below the PAA set point, the alarm LED will turn off, PAA will be cleared from the Analyzer Alarm List, and any unlatched outputs associated with PAA will return to their non-triggered state. Any latched outputs associated with this alarm will have to be manually cleared through the GUI.

- *High-High Alarm Duration* - The number of seconds entered in this field represents the time required for the High-High alarm to be active before the alarm would register. This would alleviate the alarm bouncing on and off if the concentration reading was close to the alarm set point.
- *Lock Alarm Enable*- If this box is checked then the limit value entered will be used as an alarm point. This alarm set point if pasted will lock the analyzer in whatever stream it is currently and will not allow the analyzer to proceed to other enabled gas runs.

5.10.4 Calibration, Reference and Zero Gas Tabs

5.10.4.1 Calibration Tab

The *Calibration* tab is set up very similarly to the *Sample* tab, with a few notable differences. The calibration run can be set up to automatically calibrate the analyzer and calculate a new gain factor if the analyzer is equipped with the auto-calibration option. The Calibration run can be triggered to start a number of ways such as: a discrete input, an automatic or manual sequence entry, a timed schedule entry, through the keypad or simply by hitting the Stream Calibration button.

NOTICE

If any analysis alarms have been triggered on the Sample Run (i.e. High or High High), any calibration run triggered from the GUI will be put into the run queue and not run until the alarm condition(s) has/have cleared.

5.10.4.2 Reference Tab

Reference 1 and 2 runs provide a way to check whether or not the analyzer is correctly calibrated. It is configured in much the same way as the *Calibration* run, although this run only displays the result of 1 run (or the average of 2 or more runs) on the same calibration gas as used for the calibration run. It does not recalculate the gain as the calibration run does. To determine whether or not the analyzer needs to be calibrated, run a reference. If the reading obtained by running the reference is close to the certificate for the calibration cylinder analyzed, then the analyzer is still correctly calibrated. If not, a calibration should be run immediately afterwards. The *Reference* runs can be triggered to start a number of ways such as: a discrete input, an automatic or manual sequence entry, a timed schedule entry, through the keypad or simply by pressing the *Stream Reference* button.

NOTICE

If any analysis alarms have been triggered on the Sample Run (i.e. High or High High), any calibration run triggered from the GUI will be put into the run queue and not run until the alarm condition(s) has/have cleared.

5.10.4.3 Zero Tab

The *Zero* run provides a way to check what the analyzer reads on a gas that contains no chlorine. Running a zero run will result in a zero offset being calculated for the analyzer. The zero offset can be set up similarly to the *Calibration* and *Reference* runs, can be triggered to start a number of ways such as: a discrete input, an automatic or manual sequence entry, a timed schedule entry, through the keypad or simply by hitting the *Stream Zero* button.

The *Zero* run is generally associated with a different solenoid than the *Calibration* and *Reference* runs. The *Zero* run can be configured like the *Calibration* run in that it can be set to run several analyses and take the average to calculate the zero offset.

It is important to note that a suitable zero gas is used for the *Zero* run. A suitable zero gas can be ultra-pure nitrogen, or instrument air that is known to contain no chlorine

NOTICE

if any analysis alarms have been triggered on the Sample Run (i.e. High or High High), any zero run triggered from the GUI will be put into the run queue and not run until the alarm condition(s) has/have cleared.

5.10.4.4 Differences between the Sample Tab and the Calibration/Reference/Zero Gas Tabs

The Sample tab and the Calibration/Reference/Zero Gas Tabs are quite similar in format, but the following differences between the two sets of tabs should be noted.

- *Cal Gas Concentration* indicates the concentration chlorine in the Calibration, Reference and Zero gas.
- *The Calibration and Zero Tabs* do not include the *Stream Calibration Used* field.

The *Alarms* field contain only the High Alarm Enable and % Deviation Enable options.

- *Runs to Average* - indicates the number of consecutive runs to be averaged to obtain the new gain factor during a calibration.
- *Consecutive Runs* - the Consecutive Runs field tells the analyzer how many times to run the Gas Run before switching to the next run in the run queue. If no other run is enabled and it is set up in the Automatic Sequence under the sequence tab, the analyzer will simply continue running until another run is triggered either conditionally or scheduled. By default, this field is set to 1.

5.11 Inputs- DRY Tab

There are four dry contact discrete inputs on the analyzer. The *Inputs - DRY* tab allows the user to configure these discrete inputs in any manner. These inputs can be configured to trigger a certain type of run, or to monitor external pressure or temperature switches, for example. Each discrete input is configured in the same manner. It is important to know that these dry contacts are for devices that are normally part of the analyzer such as a pressure switch or temperature switch.

NOTICE

Changing parameters on this tab may affect the operation of the system. Any changes should be performed by an authorized operator.

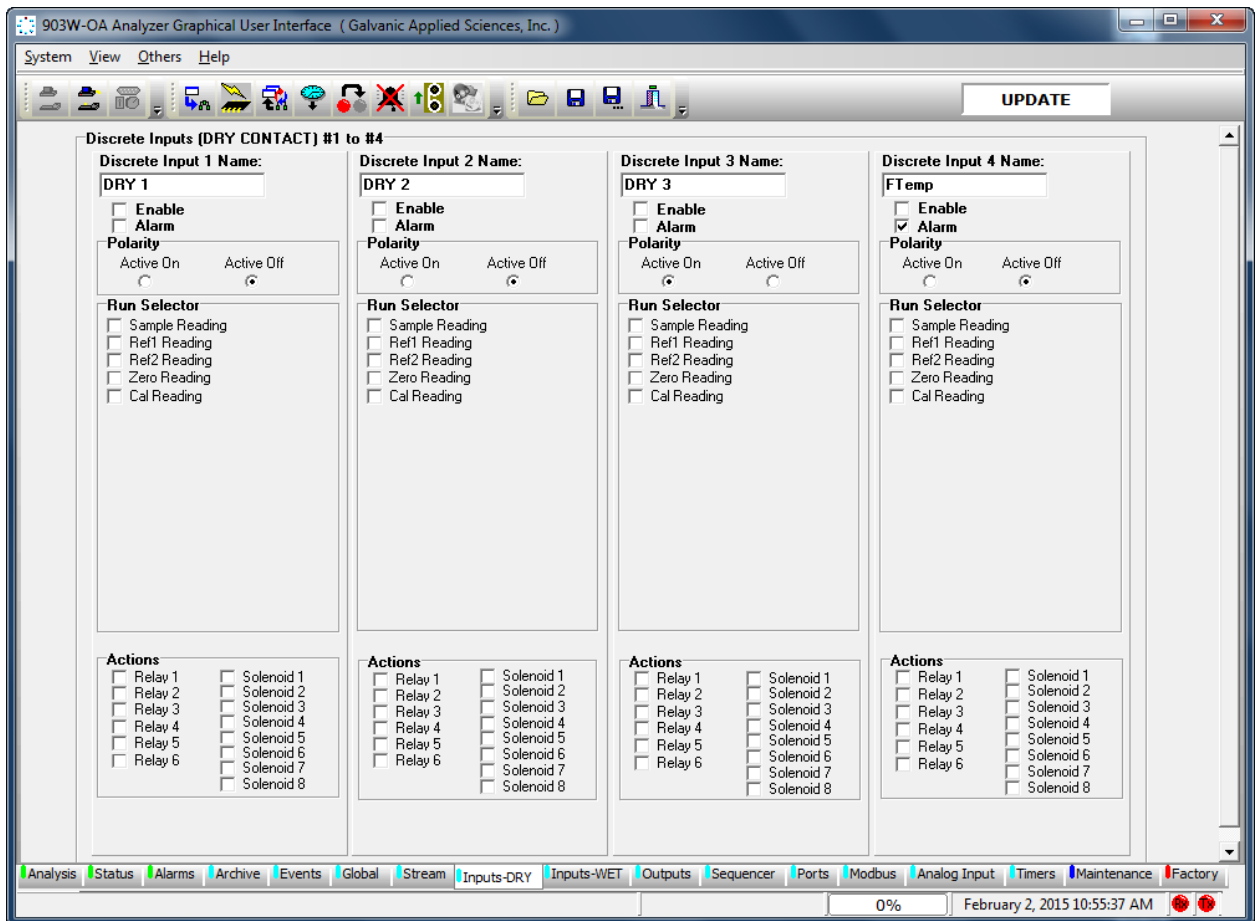

Figure 5-26: Input-Dry Tab

5.11.1 Discrete Input Name

The *Discrete Input (x) Name* can be an alphanumeric name with a maximum of six characters which will be displayed on the *Status* Tab. In addition, whenever a discrete input is triggered and the alarm checkbox is checked, its alphanumeric identifier will be displayed on the *Alarm* screen on the analyzer's LCD screen.

5.11.2 Enable & Alarm Check Boxes

If the *Enable* checkbox is enabled, the discrete input is enabled and monitored. If not, the discrete input is disabled and will not respond to any inputs. If the *Alarm* checkbox is checked, the condition of each discrete input will be logged in the *Event Log*.

5.11.3 Polarity

If the *Active On* radio button is selected, the input will be considered triggered if the contact is closed. If the *Active Off* is selected, the input will be considered triggered if the contact is opened.

5.11.4 Run Selector

The *Run Selector* box contains 24 check boxes that allow the user to select what type of gas run should be associated with each discrete input, if any.

5.11.5 Action

The *Action* box contains six Relay and eight Solenoid check boxes that allow the user to select what type of action should be associated with each discrete input, if any.

5.12 Inputs - WET Tab

NOTICE

Changing parameters on this tab may affect the operation of the system. Any changes should be performed by an authorized operator.

There are four isolated wet contact discrete inputs on the analyzer. The voltage input range required for these inputs is 4 - 24 VDC. The *Inputs - WET* tab allows the user to configure these discrete inputs in any manner. These inputs can be configured to trigger a certain type of run, or to monitor external pressure or temperature switches, for example. The *Inputs- Wet* tab is shown in Figure 5-27. Each discrete input is configured in the same manner.

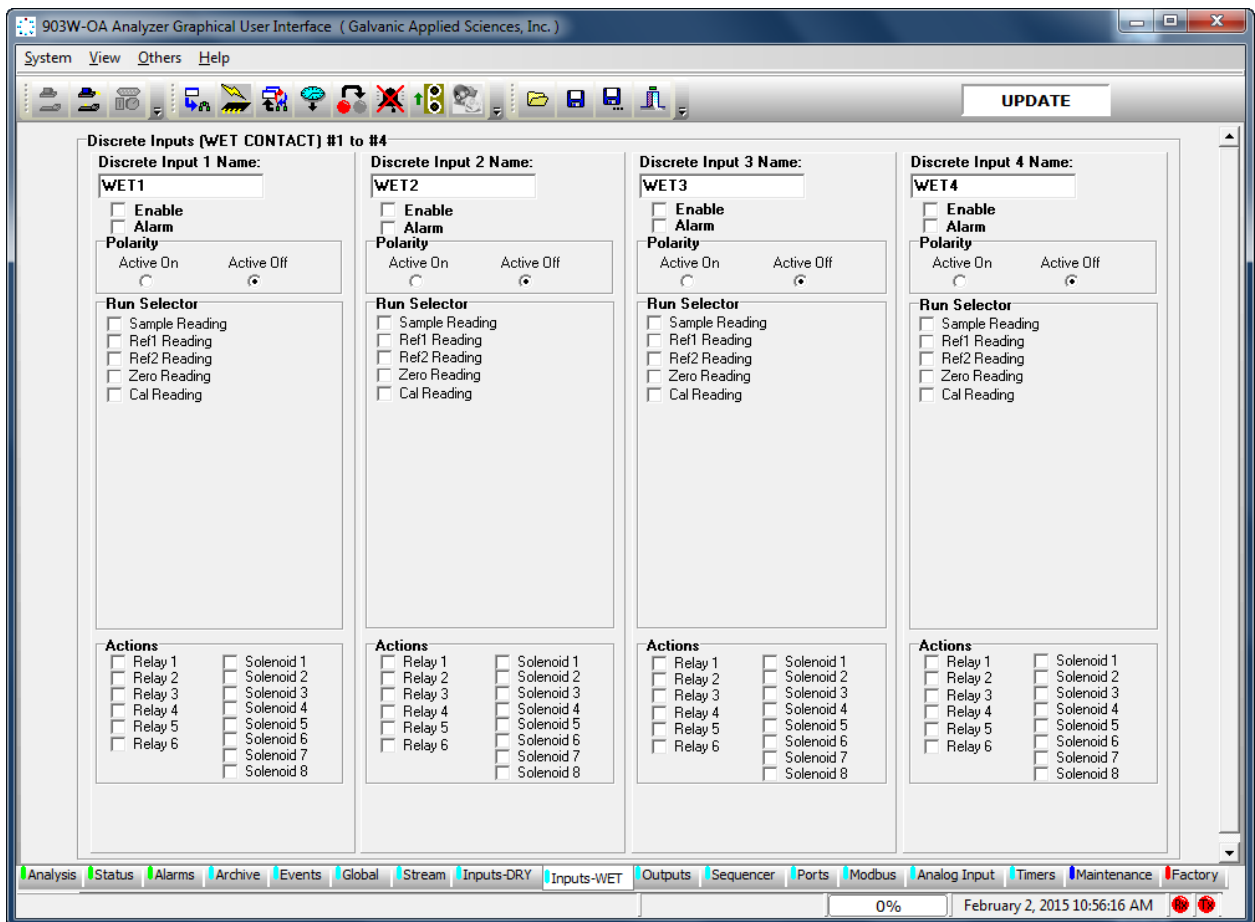

Figure 5-27: Inputs - Wet Tab

The configuration and section descriptions for this tab are identical to the *Inputs-DRY* tab (Section 5.10).

5.13 Output Tab

NOTICE

Changing parameters on this tab may affect the operation of the system. Any changes should be performed by an authorized operator.

The *Output* tab (Figure 5-28) allows the user to configure the behavior of the six onboard relays, 8 solenoids and 6 analog outputs. The *Output* tab is divided into 2 main sections: *Digital Output* and *Analog Outputs* as shown in Figure 5-28.

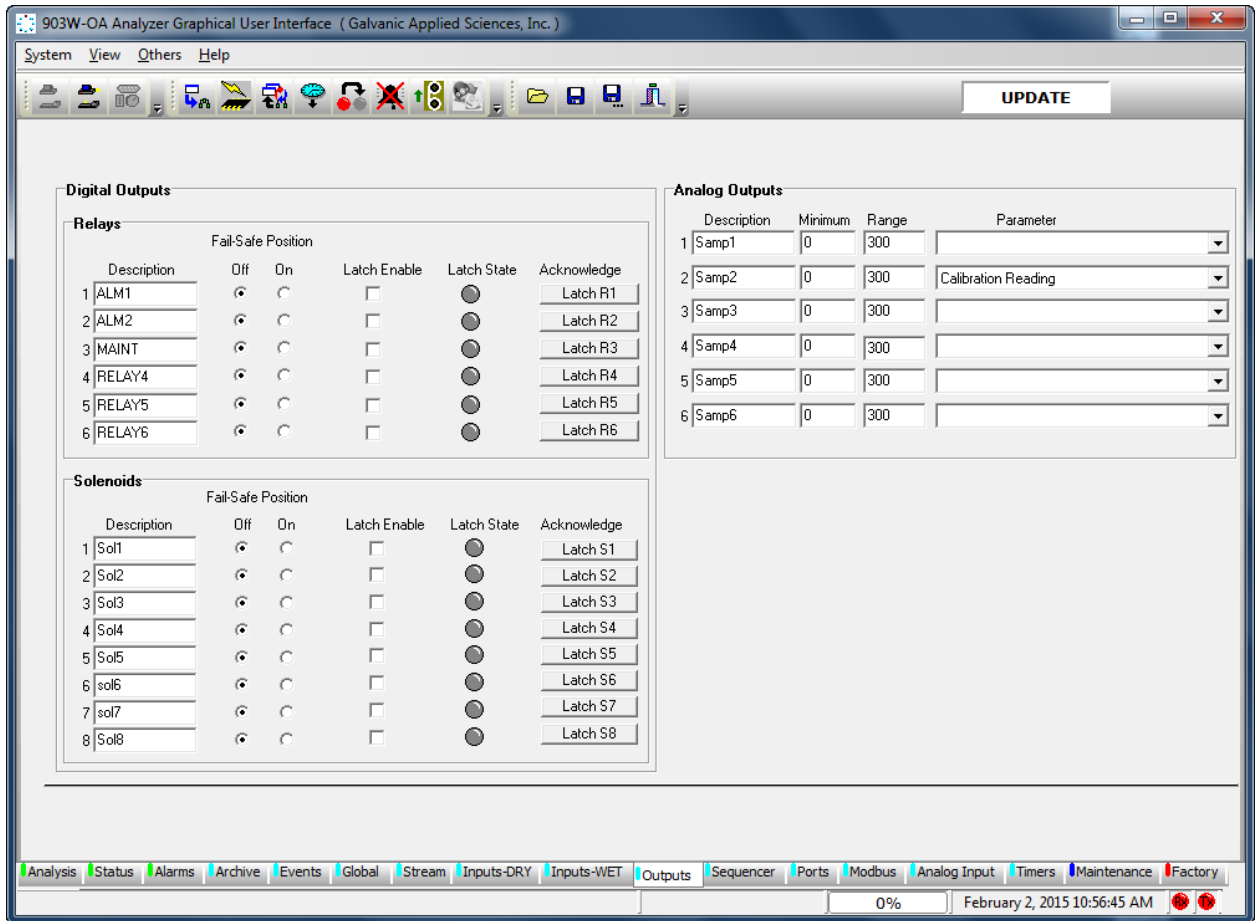



Figure 5-28: Output Tab

5.13.1 Digital Outputs and Solenoids

Each digital output has three configuration points :Description, Fail - Safe Position and Latch Enable.

- *Description* - The Description can be up to a maximum of 6 alphanumeric characters. These output descriptions will also appear in the Status tab and on the analyzer LCD screen under the CNFG menu.
- *Fail - Safe Position* – The *Fail - Safe* position is the position that the output will default to should the output not be triggered. The Fail - Safe position is also the position that the relays will switch to while the analyzer is in bypass mode. The Fail - Safe position can either be Off or On. By default the fail-safe position for both relays and solenoids is off. If an output whose fail-safe position is on is triggered by an alarm or some other event, the output will then go to the off position.
- *Latch Enable* - The Latch Enable allows the user to latch certain outputs. If an output is latched, it means that the output will stay in its triggered position until the user clears the latch, regardless of whether or not the event that triggered the output has cleared.
- *Latch State* - The state of a latch is indicated by the coloured circle under the title *Latch State*. A grey circle indicates that the output is not latched, while a red circle indicates that the output is latched.

All latched outputs can be cleared by pressing the *Acknowledge All Latches* button () in the toolbar. Alternatively, individual latches can be cleared by pressing the appropriate button in the *Acknowledge* column.

5.13.2 Analog Outputs

There are six isolated 4 – 20 mA Analog Outputs with four input fields. These fields are: *Description*, *Minimum*, *Range* and *Parameter*.

- *Description* - The *Description* can be up to a maximum of 6 alphanumeric characters. These output descriptions will also appear in the Status tab and on the analyzer LCD screen under the CNFG menu.
- *Minimum* - The *Minimum* field is used to enter the minimum numerical value that will be represented on the analog output.
- *Range* - The *Range* field is the full scale numerical value that will be represented on the analog output.
- *Parameter* - The *Parameter* field includes a drop down menu to indicate the parameter to be monitored by the analog output.

5.14 Sequencer Tab

The *Sequencer* tab (Figure 5-29) is used to generate the analyzer gas run sequences or indicate that manual operation is desired.

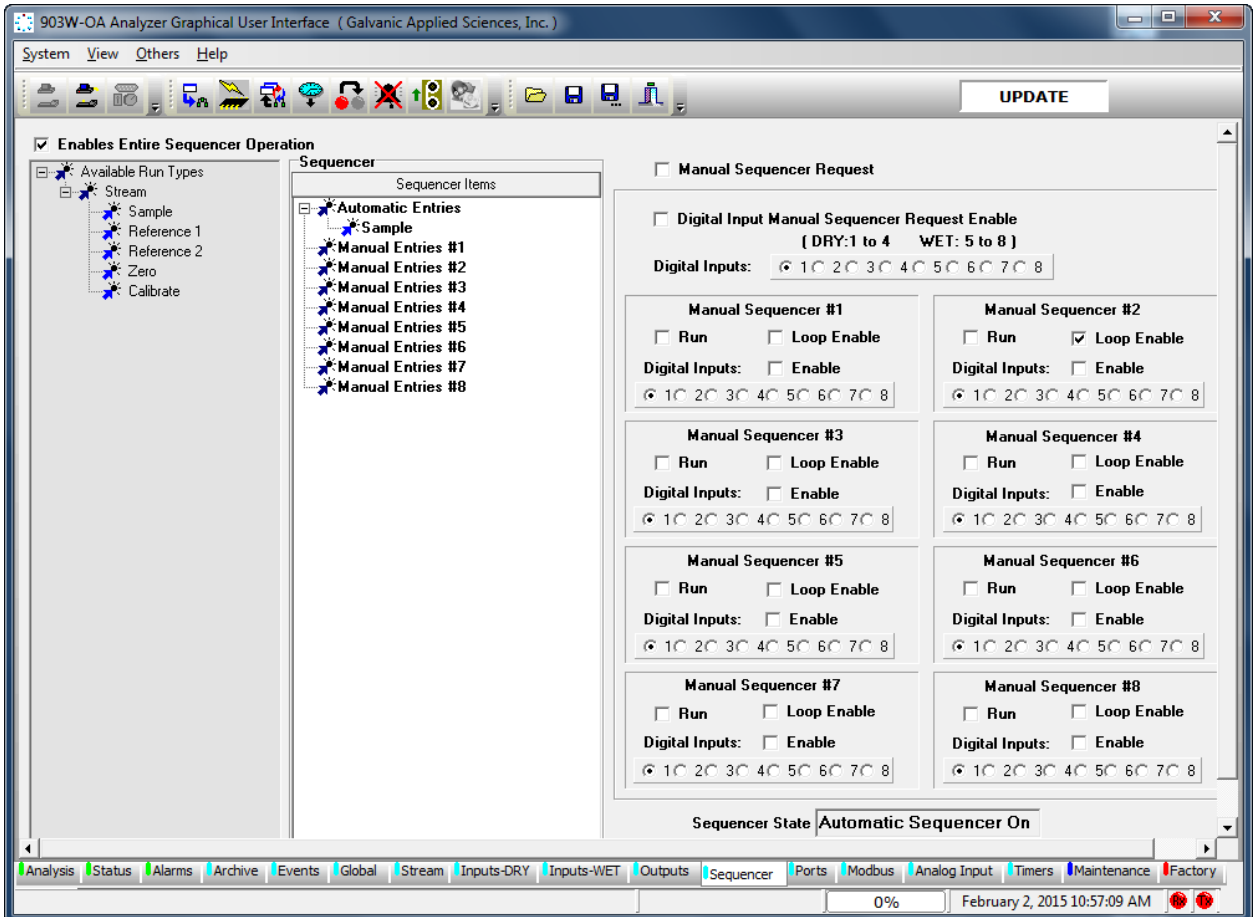

Figure 5-29: Sequencer Tab

The *Sequencer* tab is divided into three main areas: *Available Run types*, *Sequencer Items* and the *Manual Sequencer* area.

5.14.1 Enables Entire Sequencer Operation Checkbox

The *Enables Entire Sequencer Operation* checkbox must be checked for sequencer operations to execute. If this box is not checked, the analyzer will be in *Idle* mode and not analyzing the gas stream.

5.14.2 Available Run Types

A list of all the types of gas runs listed under each stream is provided on the left side of the tab. To setup a sequence of gas runs, click on the desired gas type in the Available Run Types columns and drag it to either the Automatic Entries or to one of the eight Manual Entries in the *Sequence* column.

5.14.3 Sequencer Items

A typical sequence items list is shown in Figure 5-30.

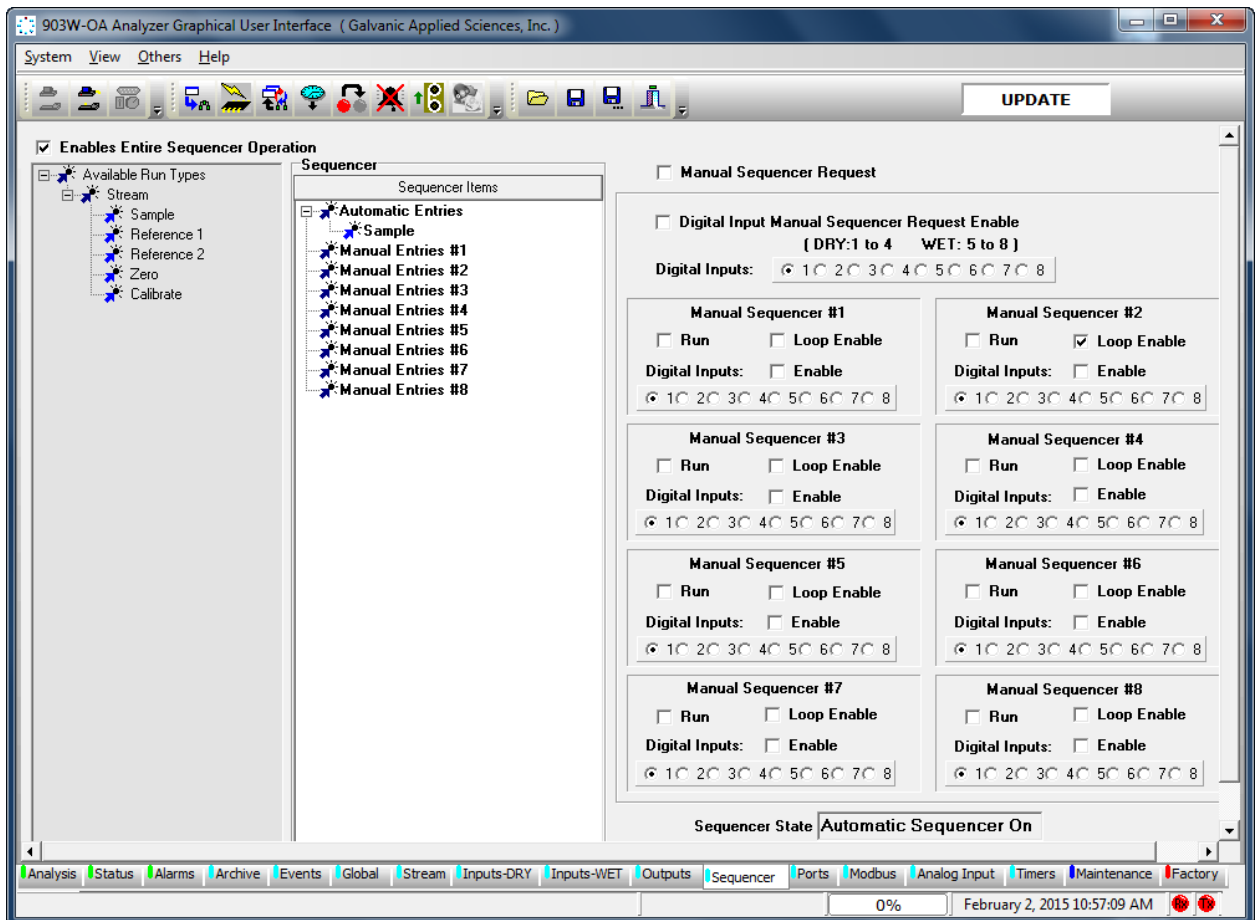

Figure 5-30: A Typical Sequencer List

If consecutive runs of a stream are desired, it is recommended that they be entered here instead of the *Stream* Tab. The reason for this is that the consecutive gas runs cannot be interrupted midway through if they are entered via the *Streams* tab while they can be interrupted if they are programmed on the *Sequencer* tab.

The pink highlighted run indicates that this is current run in the sequence that is being performed.

To remove an item from the sequence list, click on it to highlight the line blue and use the *Delete* Key on the keyboard.

5.14.4 Manual Sequencer Request Checkbox

The *Manual Sequencer Request* checkbox must be checked before a manual sequence can be performed.

5.14.5 Digital Input Manual Sequencer Request Enable Checkbox

The *Digital Input Manual Sequencer Request Enable* checkbox should be checked, if the operator wants to initiate a manual sequence option from a digital input. As seen in Figure 5-31, closing Digital Input 1 contact would now allow any of the 8 digital contacts to be used to initiate a Manual sequence.

The screenshot displays the configuration interface for the Manual Sequencer. At the top, there is a checkbox labeled "Manual Sequencer Request". Below this is a section titled "Digital Inputs Configuration for Manual Mode" which contains a checkbox for "Digital Input Manual Sequencer Request Enable" and a note "[DRY: 1 to 4 WET: 5 to 8]". A "Digital Inputs:" field shows a row of 8 radio buttons, with the first one (1) selected. Below this are eight individual configuration boxes for "Manual Sequencer #1" through "Manual Sequencer #8". Each box contains checkboxes for "Run", "Loop Enable", and "Digital Inputs: Enable", along with a "Digital Inputs:" field of 8 radio buttons. At the bottom, a "Sequencer State" field shows "Automatic Sequencer On".

Figure 5-31: Manual Sequencer Fields

5.14.6 Manual Sequencer # 1 - 8

Each of the eight manual sequencer boxes includes the following options:

- *Run and Loop Enable Checkboxes* - When the *Manual Sequencer Request* checkbox is checked, the user can run individual manual sequences by checking the *Run* checkbox for any particular manual sequence. The *Loop Enable* checkbox can also be checked to allow the manual sequence to run indefinitely.

NOTICE

The Run and Loop Checkboxes can be ignored if a digital input is used to run a manual sequence because the sequence would run continuously until the digital input was put in an open state.

- *Digital Input Checkbox* - The *Digital Input* checkbox should be checked to enable the dedicated digital contact for that manual sequencer to initiate.

5.15 Ports Tab

The *Ports* tab (Figure 5-32) shows the configuration of the three communications ports on the analyzer – the **Front Panel Serial Port (RS-232)**, the **ISO 485 Port (RS-485)**, and the **MODEM Port (RS-232)**.

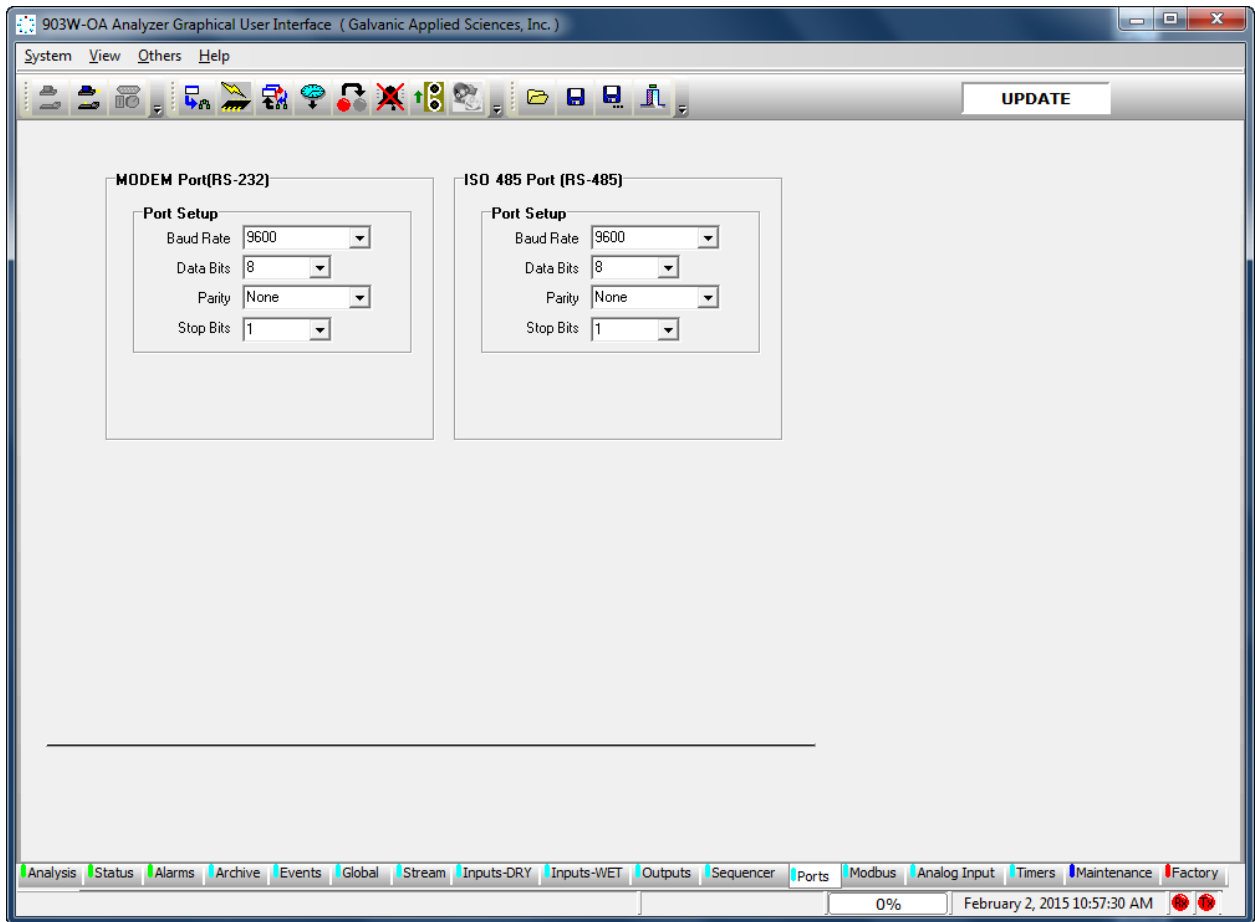

Figure 5-32: Ports Tab

This tab is used to configure the communications settings for each of the three communications ports.

5.16 Modbus Tab

The *Modbus* tab allows the user to set up the analyzer to output data in 3 varieties of MODBUS communication protocol - Enron, Modicon 16, and Modicon Floating Point. As there are a large number of possible configurations for Modbus, and every user may desire a slightly different configuration, this manual will only cover the basics of Modbus configuration. If the user requires assistance in setting up a Modbus configuration, the Service department at Galvanic Applied Sciences Inc. will assist in configuring the unit as desired.

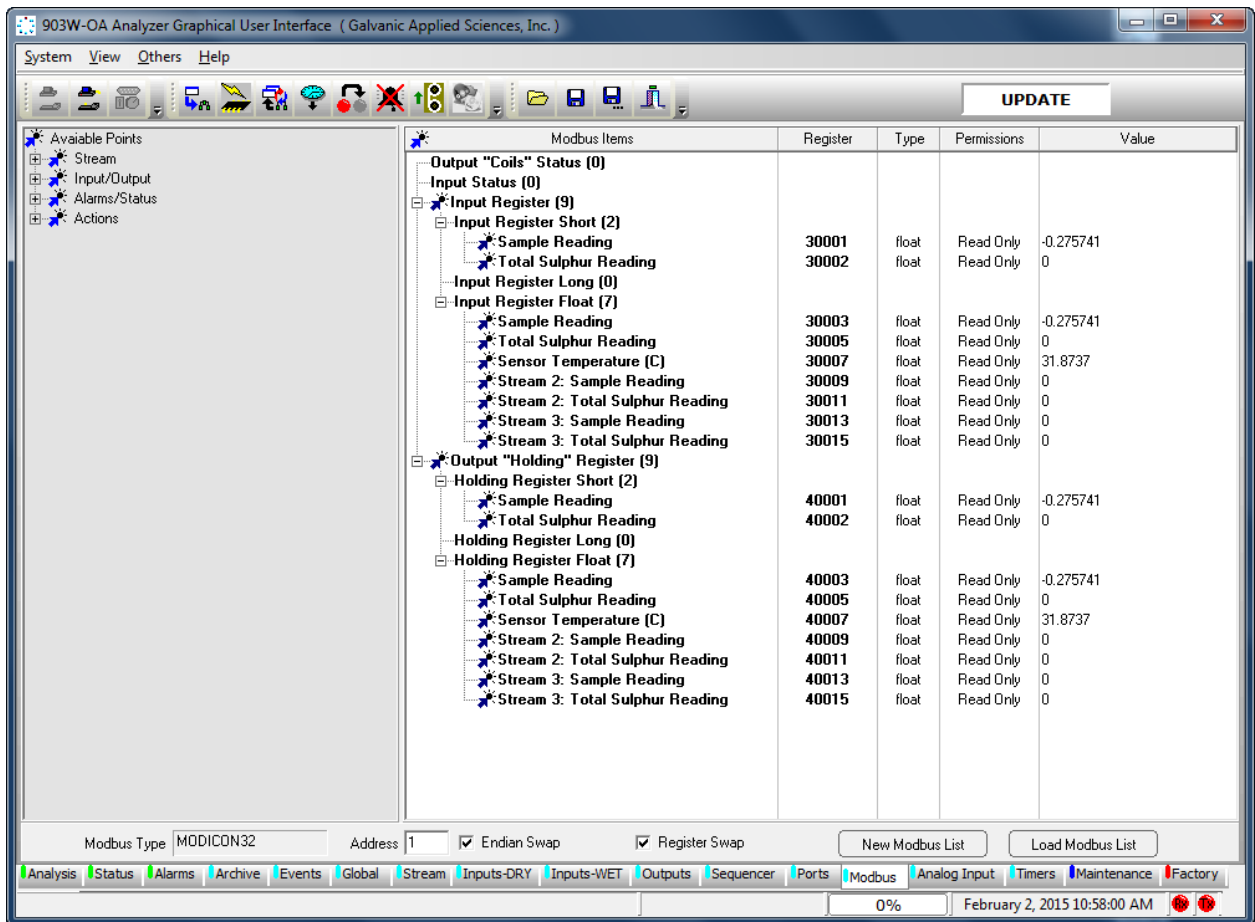

Figure 5-33: Modbus Tab

To set up a new Modbus list, press the *New Modbus List* button at the bottom of the screen. This will bring up the dialogue box shown in Figure 5-34.

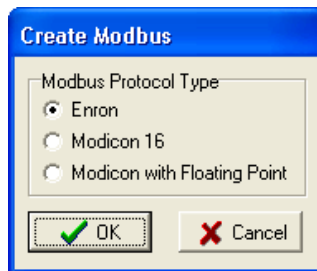

Figure 5-34: Create Modbus List Dialogue Box

The dialog box gives the choice of the 3 possible types of Modbus. Select the desired type of Modbus list and press *OK*. When a new Modbus list is opened, one of three possible empty trees appears in the main Modbus window, depending on the type of Modbus chosen. The three possible Modbus trees are shown in Figure 5-35.

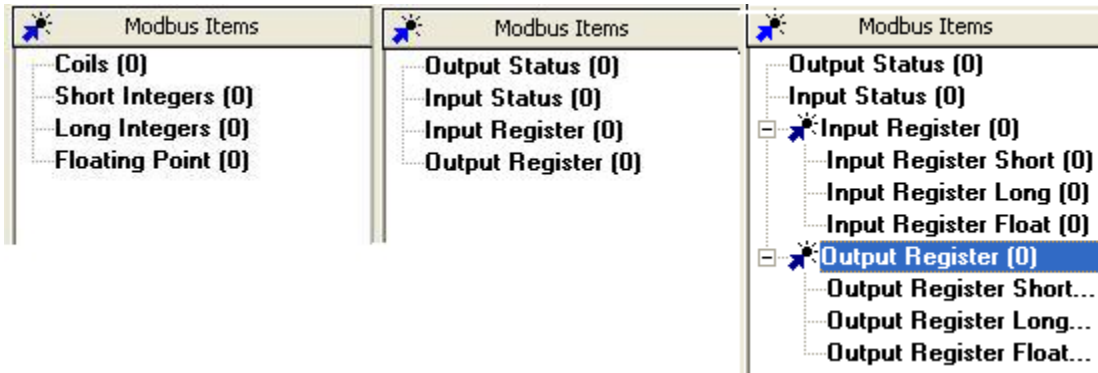

Figure 5-35: Empty Modbus Trees

The Enron tree is at left, the Modicon 16 tree is in the centre, and the Modicon with Floating Point Tree is at the right. The number in brackets after each node label indicates how many data points are in each node.

At the bottom of the screen are two fields. One is entitled *Modbus Type* and tells the user what type of Modbus list currently open. Note that the value in this field for Modicon with Floating Point will read *MODICON32*. The other field is called *Address*, and the user must input the desired Modbus address for the analyzer into this field.

5.16.1 Enron

An Enron Modbus list contains 4 nodes on the Modbus tree. They are *Coils*, *Short Integers*, *Long Integers*, and *Floating Point*. Coils are Boolean data points – that is to say, they have a value of either 0 or 1. To that end, data points entered into the Coils node would usually be data points that are simple status indicators, indicating the status of a given alarm, input, or output. If the value of the data point is 0, the status of the logged alarm, relay, etc, would be off, and if the value is 1, the status would be on. Short integers are 16 bit whole numbers with either positive or negative sign. Long integers are 32 bit whole numbers with either positive or negative sign. Floating point values are also 32 bit numbers, but unlike the integers they do not have a sign, but they do have decimal points.

5.16.2 Modicon 16

A Modicon 16 Modbus list contains 4 nodes on the Modbus tree. They **are Output Status, Input Status, Input Register, and Output Register**. The Input and Output Status nodes contain Boolean data points. Data points in the Output Status node are able to be written to, so the Output Status node can contain data points such as stream requests. If the value in a given stream was changed from 0 to 1, the analyzer would then initiate that stream. Data points in the Input Status node are read-only, so this node would contain data points such as alarm, input, and output status that cannot be changed remotely. Input Registers are data points that are read-only outputs of analyzer data, such as calculated concentration. Please note that Modicon 16 only outputs data as 16 bit numbers, so the display of decimal points in this type of Modbus list is not possible. Output Register contains non-Boolean data points that can be written to remotely. These would include such things as tape length, calibration gas concentration, and gain factor.

5.16.3 Modicon with Floating Point

Just like the Modicon 16 Modbus list, the Modicon with Floating Point (MODICON 32) list contains 4 main nodes on the Modbus tree. However, the Input and Output Registers contain sub-nodes. They are **Register Short, Register Long, and Register Float**. Thus, the input and output registers can output data in 16-bit, 32-bit, or 32-bit with floating point in the Modicon with Floating Point Modbus list.

5.16.4 A Typical Modbus Setup

The default Modbus setup for the analyzer uses the Modicon with Floating point format. Data points are added to the Modbus list in much the same way that data points are added to the Archive. Figure 5-36 shows a typically configured Modicon with Floating Point Modbus list.

On the left hand side of the screen is a narrow field entitled *Available Points*. Under this field are seven expandable nodes which are: Streams 1 through 4, Inputs/Outputs, Alarms/Status and Actions. Figure 5-36 shows a typical Modcon list with Floating Point List and Figure 5-37 shows a sample of the available points under each expandable node.

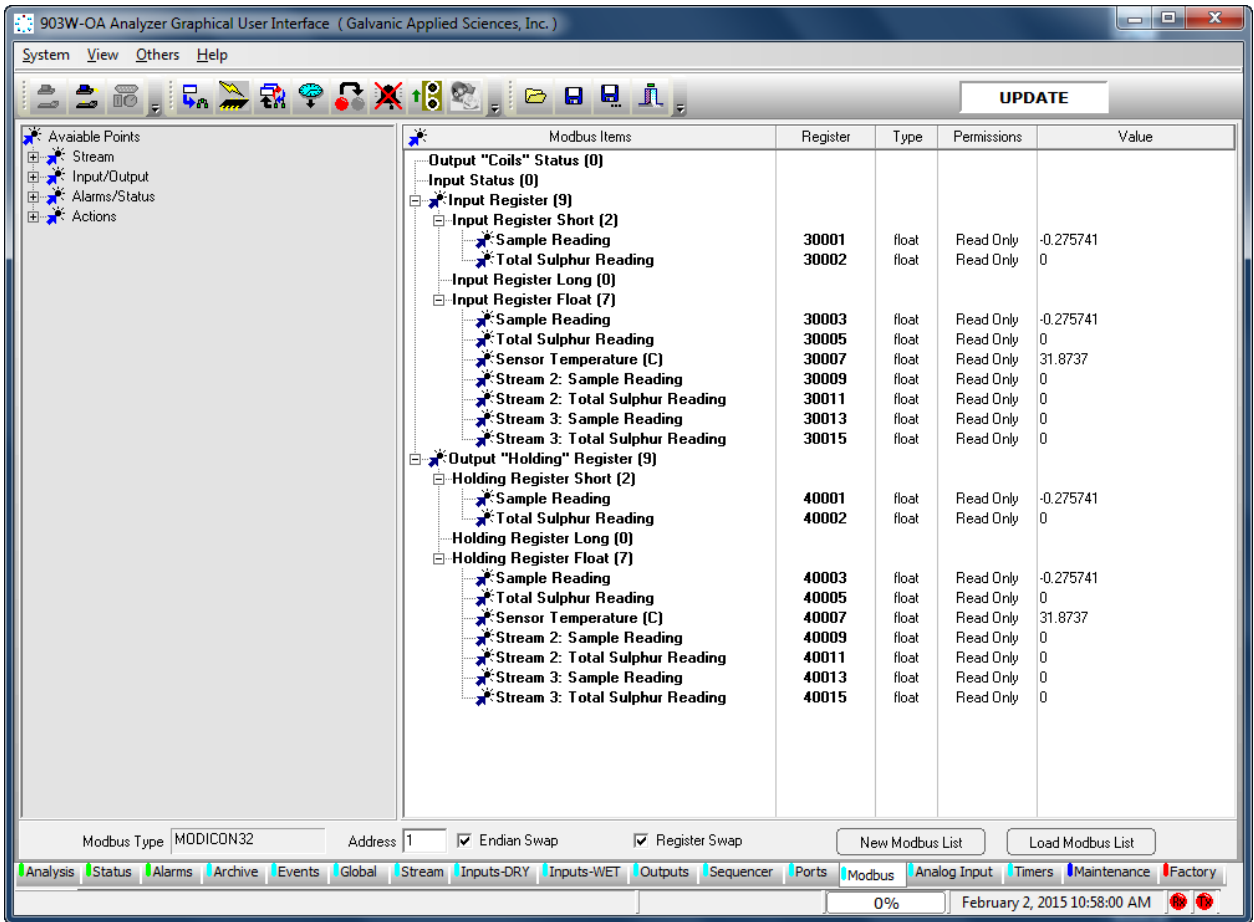

Figure 5-36: Typical Modcon with Floating Point List

5.17 Analog Input Tab

The *Analog Input* tab (Figure 5-39) is divided into two main sections: *Analog Inputs # 1 - 4* and *Analog Inputs Alarm*:

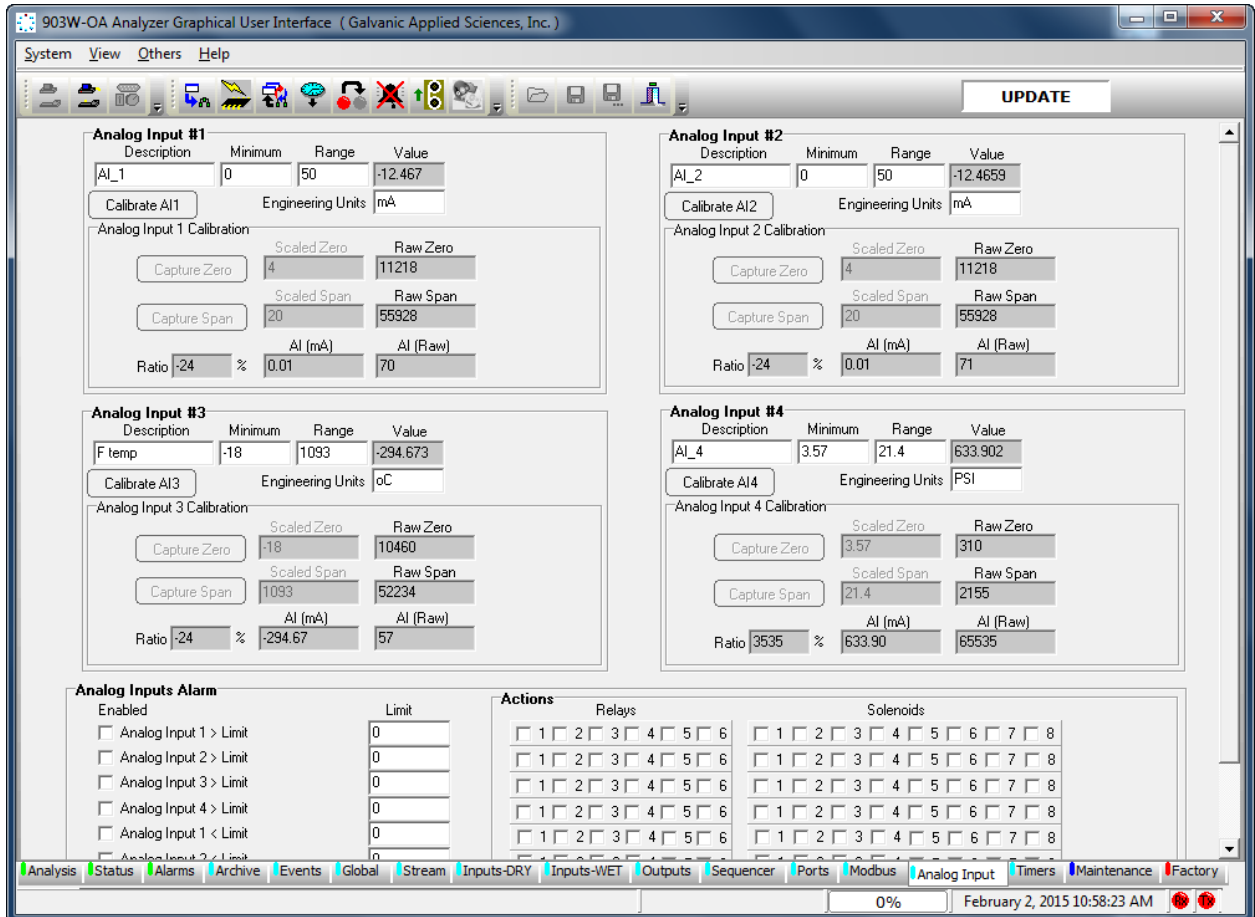

Figure 5-39: Analog Input

5.17.1 Analog Input

There are four analog inputs, each of which contain are six data entry fields, six results fields and three initiate buttons which are described below.

- *Analog Input #1, #2 and #3* are normally setup as default 4 -20 mA inputs but all the inputs can be scaled to what the operator requires.
- *Analog # 4* default setup is for an optional pressure transducer for live pressure readings. Within each of the Analog Input boxes are six data entry fields, six results fields and three initiate buttons which are described in Section 6.16.2.

5.17.2 Analog Input Parameters and Controls

The Analog inputs and controls include:

- *Description* - used to enter the Analog Input descriptor. This information will appear under the Analog Inputs section on the Status Tab and on the analyzer LCD display
- *Minimum* - the lower limit of the range (typically zero).
- *Range* - the maximum or span limit of the range.
- *Value* - the calculated range value for a given 4 – 20 mA input.
- *Engineering Units* - the units that correspond to the type of analog input (e.g. ppm, %, psig, etc).
- *Calibrate A. I. #* - when this button is pressed the *Scaled Zero* and *Scaled Span* fields will be activated and the appropriate values can be entered.
- *Capture Zero* - used to capture the A/D bits that are associated with a 4mA input during the calibration of the analog input.
- *Scaled Zero* - used to enter the zero value or the range. For a 4 – 20 ma range, the 4 mA value would be entered.
- *Raw Zero* - shows the A/D bit count for the 4mA input.
- *Capture Span* - used to capture the A/D bits that are associated with a 20mA input during the calibration of the analog input.
- *Scaled Span* - used to enter the span value or the range. For a 4 – 20 ma range, the 20 mA value would be entered.
- *Raw Span* - shows the A/D bit count for the 20 mA input

5.17.3 Analog Inputs Alarm

The *Analog Inputs Alarm* fields are used to select the input alarms to be used, the limit for the input and the solenoid or relay to be used for that alarm. The appropriate check box should be selected for each input.

5.18 Timers Tab

The *Timers* tab (Figure 5-40) offers another powerful way to trigger conditional gas run requests other than the ones on the *Streams* tab. Manual Sequences can also be triggered using start and stop timer set points.

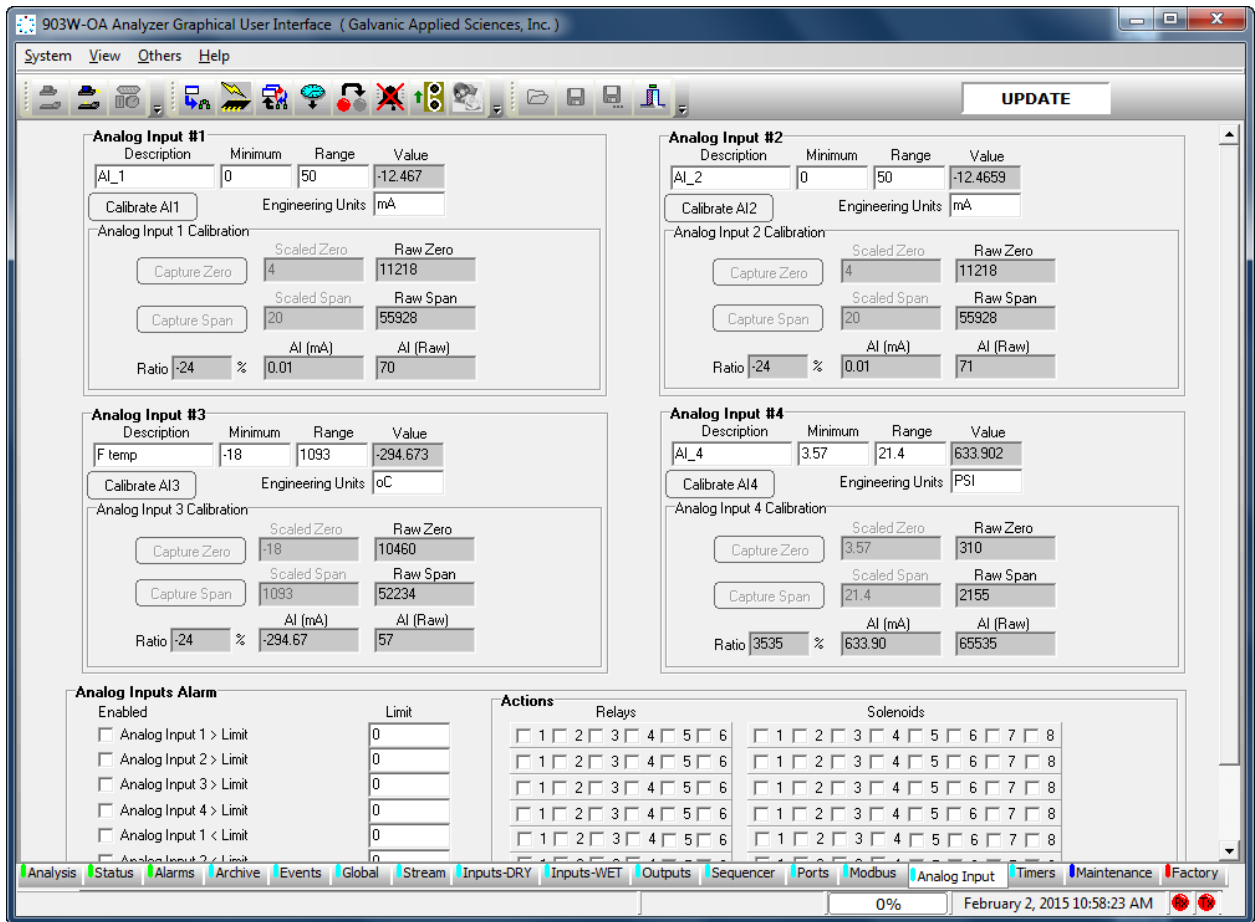

Figure 5-40: Timers Tab

NOTICE

It is important to note that any conditional events will only commence after the previous run is completed. For example: if a Zero gas run is scheduled to start at 8:00 AM and just before that time a Sample run starts an analysis, the Zero gas run will wait until the Sample analysis is finished. Therefore all timed conditional events may not start at the exact time as scheduled.

5.18.1 Schedule

The Schedule for each timer consists of the *Day* field where any specific day or “every day” can be selected from the pull down menu and the *Hour* and *Minute* fields. The time fields operate on 24 hour military time (e.g. 3:00AM=0300, 3:00PM=15:00_).

NOTICE

The analyzer cannot execute any timed gas runs scheduled from 12:00 AM to 12:59AM. In this mode, normally the time 00:15 would signify 15 minutes past midnight but for this application putting a zero in the hour field would tell the analyzer to do whatever is scheduled in that column to run every hour.

5.18.2 Analysis

The *Enable* checkbox must be checked before any of the gas runs listed below can be executed on a timer. For any of the analysis types, the schedule time would be used to initiate a single operation which may consist of one run or as many runs indicated in the consecutive box located for that run type on the streams tab.

5.18.3 Sequences

The operations in this section are *Manual Sequences* that can be set to run for any specific time period up to a week. The manual sequencers require a Start time and a Stop time: therefore the date and time on two timers need to be entered. The *Start* and *Stop* checkboxes also need to be checked to enable this operation to execute.

5.19 Maintenance Tab

The *Maintenance* tab (Figure 5-41) allows the operator to calibrate the six analog outputs and test the operation of any of the relays or solenoids under direct board control. This feature is useful during analyzer commissioning.

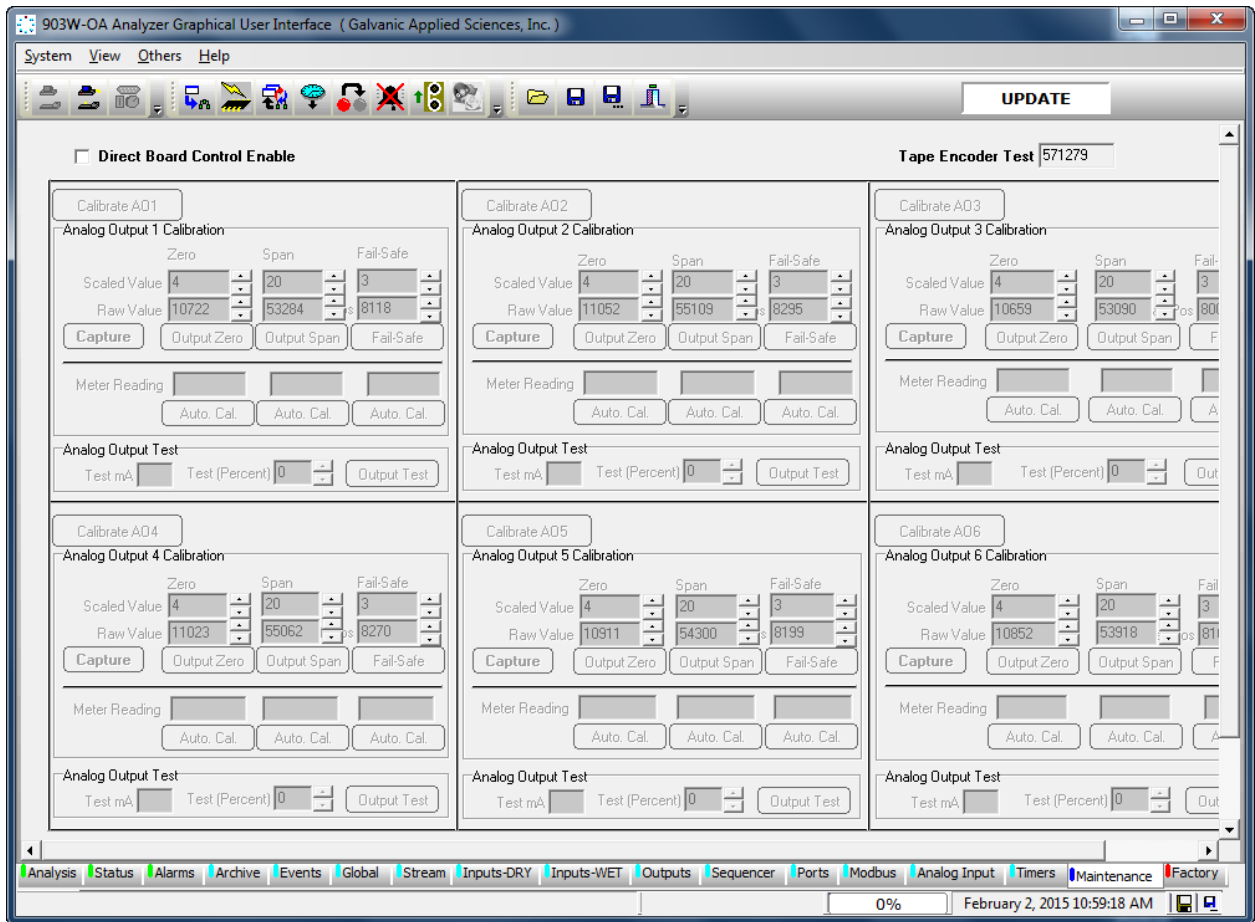

Figure 5-41: Maintenance Tab

NOTICE

Changing Parameters in the Maintenance tab may affect operation of the unit. It is recommended that any change in this page be done by authorised personnel only.

5.19.1 Entering the Calibration Mode

To test/calibrate the hardware, the *Direct Board Control Enable* checkbox must be checked. This will present the warning depicted in Figure 5-42.

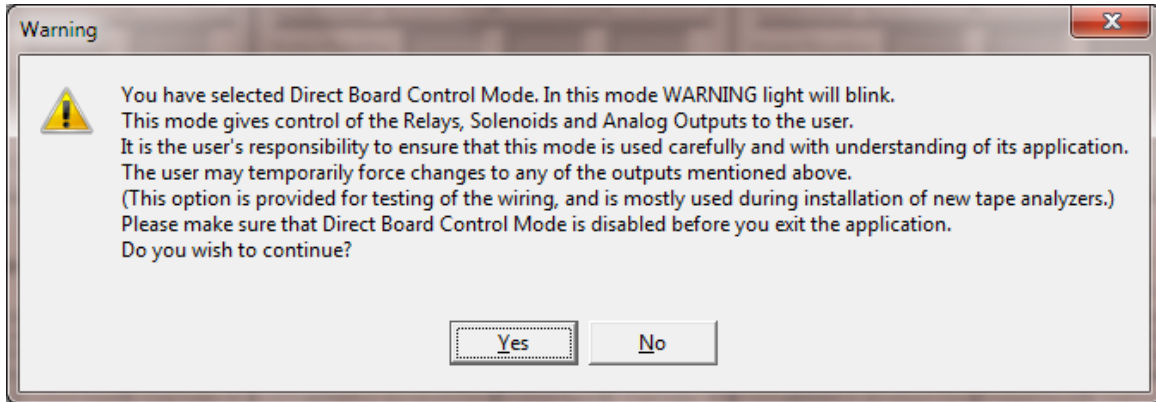

Figure 5-42: Direct Board Control Warning

When the *Direct Board Control Enable* checkbox is selected, any changes made on this tab will be written directly to the board. The Warning light on the analyzer's front panel will blink red, notifying the user of this condition.

NOTICE

Direct board control will automatically be disabled if the user changes to any other screen in the GUI. However, it will not automatically be disabled should the GUI be exited directly from the *Maintenance* screen without first removing the checkmark from this box.

NOTICE

IMPORTANT: If the analyzer is left in direct board control enable mode, no outputs will be updated during an analysis, so it is essential that this checkbox be unchecked before exiting the GUI. The *Maintenance* screen allows the user to calibrate and test the analog outputs, test the discrete outputs, and test the pulse counter.

5.19.2 Calibrating Analog Outputs



This procedure requires that the interior of the system is accessed. After the calibration procedure is completed, it is necessary to ensure that the system meets the appropriate safety classification requirements (Class 1, Div. 2, Group B, C &D).

Each analog output must be calibrated individually. To calibrate analog outputs, a multimeter set to measure milliamps must be connected across the analog output, and the analog output must be powered, as the analyzer motherboard does not provide power to the analog outputs. When the analog output is correctly powered, a green LED will glow on the electronics board next to the AO terminal block.

To calibrate analog output 1:

- a) Connect the multimeter to the AO 1 terminal block on the right side of the motherboard.
- b) Press the *Calibrate AO 1* button in the GUI. In the *Analog Output 1 Calibration* box, there are six user-adjustable fields, arranged. The Scaled Value for zero, span, and fail-safe tell the analyzer what currents should be output to the AO when the data point being sent to the AO has a value equal to its minimum or maximum output value or when the analyzer is in bypass (fail-safe) mode.
- c) Press the *Output Zero* button. The analog output will attempt to output 4 mA. Note the actual mA output on a meter and enter this value into the Meter Reading Field below the Output Zero button. Next press the Auto Cal button located below the Meter Reading Field. This will cause the analog output to be calibrated to exactly 4 mA.
- d) Once the multimeter does read this exact value, press the *Output Span* button and repeat the process. This time, the meter should be made to read exactly the value in the scaled value field in the span column, usually exactly 20 milliamps.
- e) Calibrate the fail-safe position. The fail-safe position is the value that the analog output will output when the analyzer is in bypass mode, and is a value outside the standard scaled range of the analog output. For example, if the analog output is scaled to output 4 to 20 milliamps, the fail-safe value could be 3 or 21 milliamps. To calibrate the fail-safe position, press the *Fail-Safe* button and follow the same procedures as the Zero and span calibration.
- f) Once the analog output is correctly calibrated, press the *Capture* button to write this new configuration to the analyzer.
- g) Test that the output works correctly using the *Analog Output Test* box. Enter a value between 0 and 100 into the *Test (Percent)* field and ensure that the reading on the multimeter is the same as the reading in the *Test mA* field. If it is not, the calibration is not correct, and needs to be changed. If it is, the calibration is correct. Press the *Calibrate AO 1* button again to close this field

The above process should be repeated for each analog output. Once all analog outputs are calibrated, press the *Permanent Configuration Write to Analyzer* () button to permanently write the new Analog Output configuration to the analyzer.

5.20 Factory Tab

The *Factory* tab (Figure 5-43) is password protected. All the parameters on this tab is set in the factory and should only be changed by authorized personnel.

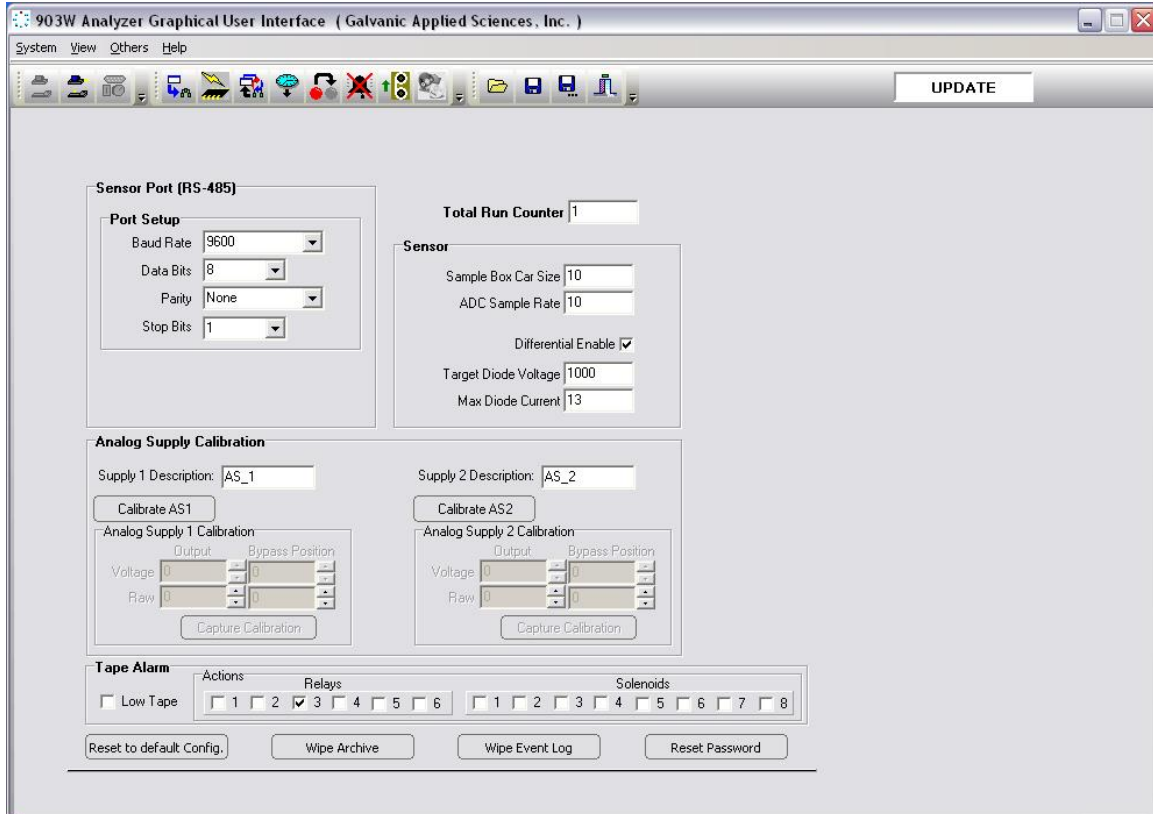

Figure 5-43: Factory Tab

Section 6 **Operating the System**

6.1 Introduction

The overall operation of the system is based on the information entered on the application program on the personal computer and downloaded to the analyzer. The *Analysis* tab of the GUI will present the present status of the analyzer and the most recent analytical results. In addition, the *Archive* tab can be used to view previously collected data.

The collection of analytical parameters, settings, alarms and related information regarding analyzer operation is called a “configuration”. If the operator has selected *Update* mode, the existing configuration can be retrieved from the analyzer, edited and then downloaded to the analyzer.

The role of this chapter is to provide a short overview of the application program from an operational point of view. It assumes that the system has been installed as described in Chapter 3 (i.e. the analyzer has been connected to the personal computer and the *Update* mode all input and output devices have been interfaced). In this chapter, we will simply point out how each tab in the application program fits into the entire operation of the system. A detailed discussion of each tab is presented in Chapter 5.

While the configuration is established by the GUI on the personal computer, the hand held keypad can be used to monitor a broad range of instrument parameters. The use of the keypad is presented in Chapter 4. In addition, a series of LED's on the panel of the controller module provide information about the status of the analyzer

6.2 Editing a Configuration

6.2.1 Accessing the Active Configuration

A configuration is generated as a part of the manufacturing, QA and final acceptance steps and is stored in the analyzer when the unit is shipped to the end user. When the GUI is opened and the operator logs onto the analyzer, the present configuration is downloaded to the computer.

If the operator wants to edit the active configuration that is in the controller module, it is necessary to log on to the system in *Update* mode.

6.2.2 Types of Parameters in a Configuration

A configuration contains a broad range of parameters and settings that govern the operation of the system. These fall into two general groups:

- Commonly edited parameters and settings that are closely related to the desired measurement(s). (Section 6.3).
- Parameters and settings that are changed relatively infrequently once they are set, such as the relay assigned to a specific alarm and the high or low alarm limits (Section 6.4).

6.2.3 General Guidelines for Editing Parameters

NOTICE

If a change is made to any data on a tab, it is necessary to save the change before you move to another tab by pressing the *Write Current Page to Analyzer* button (Figure 6-1) or the *Permanent Configuration Write to the Analyzer* button (Figure 6-2).



Figure 6-1: Write Current Page to Analyzer Button



Figure 6-2: Permanent Configuration Write to the Analyzer Button

The *Write Current Page to Analyzer* allows you to store and view your analyzer configuration and its behaviour before you make a decision to permanently accept the change.

NOTICE

If information has been written to the analyzer via the *Write Current Page to Analyzer* button, a re-boot of the analyzer will cause the information to be lost unless a *Permanent Write to Analyzer* has been performed.

The *Permanent Configuration Write to the Analyzer* button sends a command to the analyzer and will start the process of copying data from analyzer memory to the analyzer hard drive. This process takes about 30 seconds to complete. After this step, all the changes are permanently stored to the analyzer.

6.3 Commonly Edited Parameters

There are two tabs in the application program that are commonly used to set up the parameters for analyses.

6.3.1 The Streams Tab

Four different types of samples can be analyzed, analytical samples, reference samples, calibration samples, zero samples. The *Stream* tab (Figure 6-3) is used to enter information about each type of sample, timing information and alarm levels. A detailed discussion of the *Streams* tab is presented in Section 5.10.

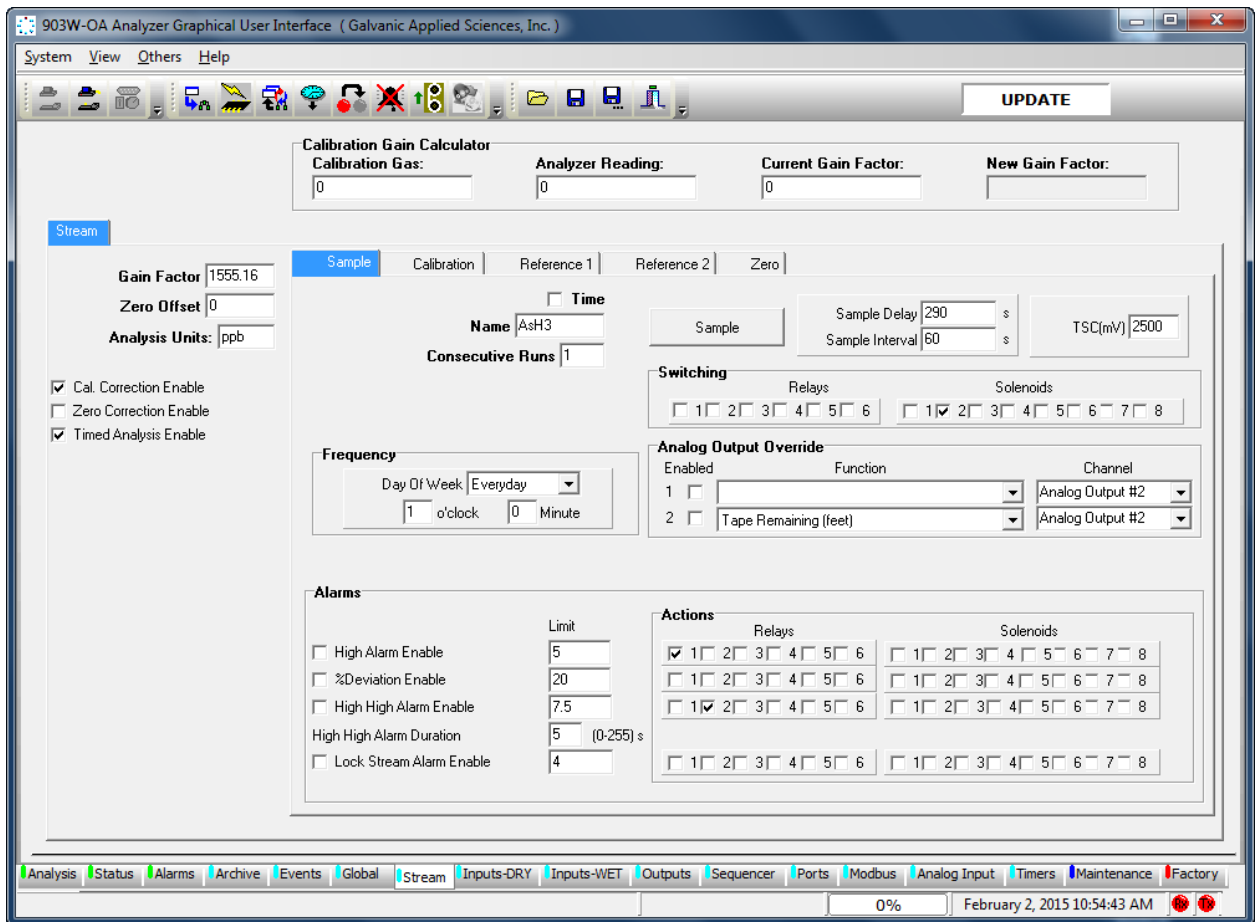

Figure 6-3: Streams Tab

NOTICE

When you have completed editing a tab, press the Temporary Write button before going to another tab or page.

6.3.2 Sequencer Tab

The *Sequencer* tab (Figure 6-4) is used to create analyzer gas run sequences. The user can set up the analyzer gas run sequences to initiate either automatically or manually. A detailed discussion of the *Sequencer* tab is presented in Section 5.14.

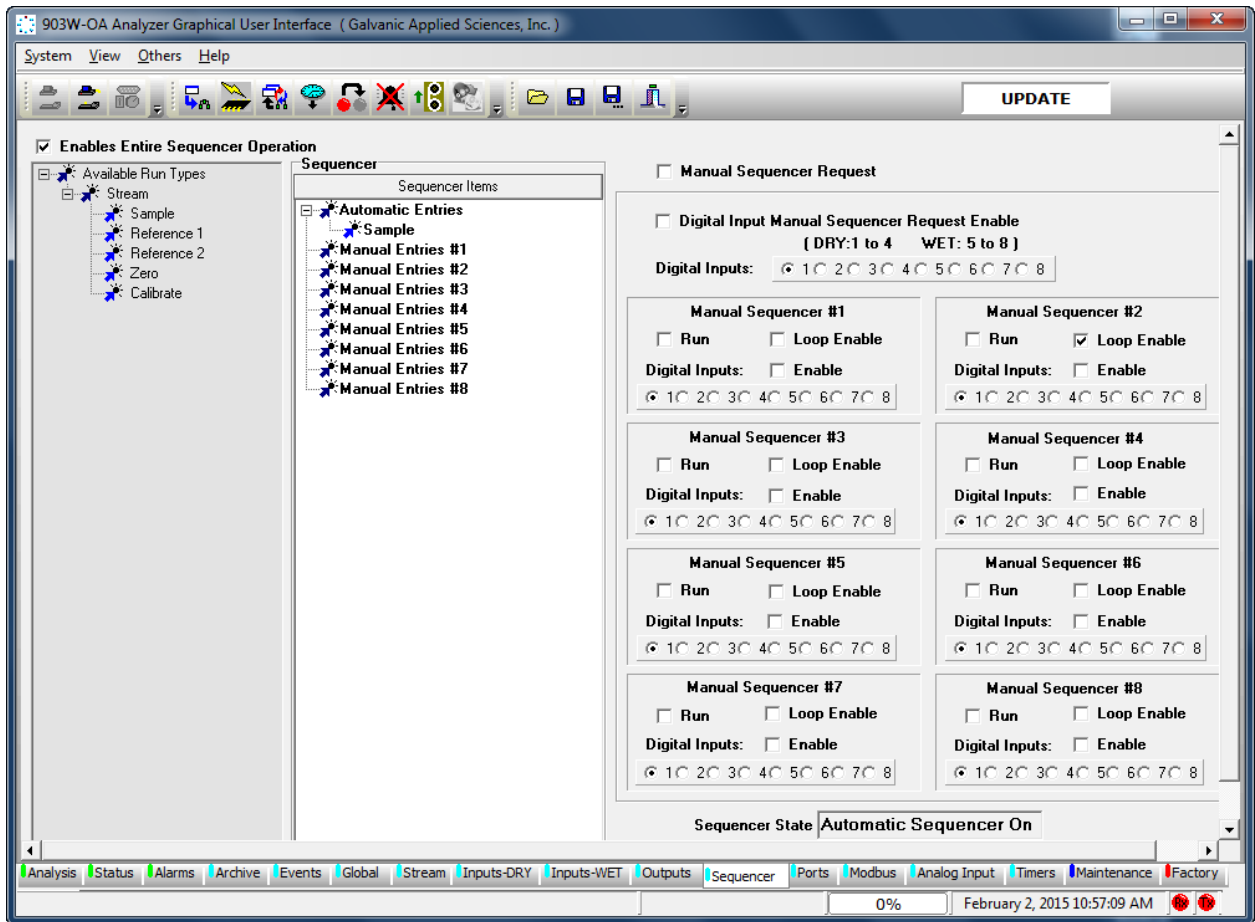

Figure 6-4: Sequencer Tab

6.4 Less Commonly Edited Analyzer Parameters

Many instrumental parameters are set when the analyzer is initially installed and once they are set, they are infrequently edited.

6.4.1 The Global Tab

The *Global* tab (Figure 6-5) used to establish a broad range of system related parameters. A detailed discussion of the *Global* tab is presented in Section 5.9.

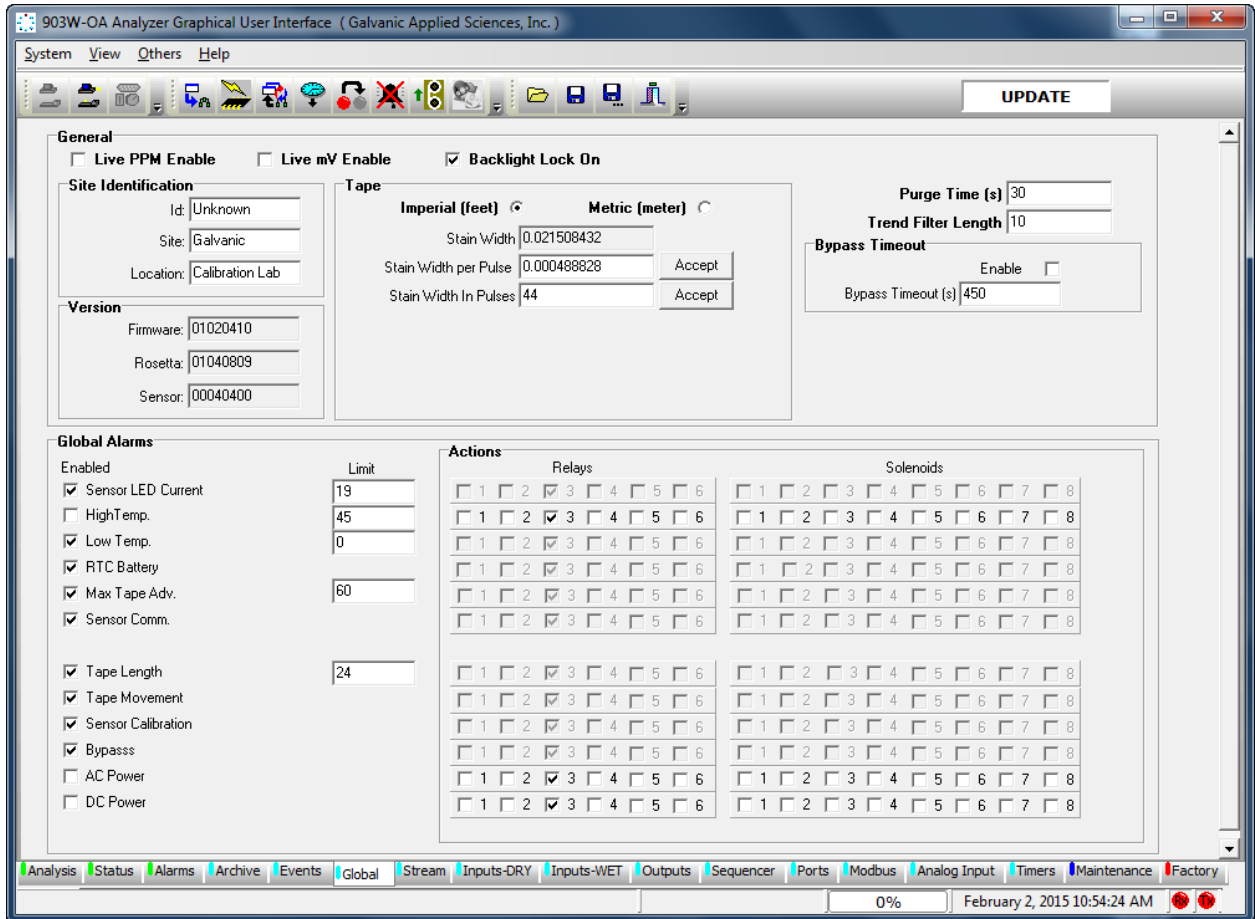

Figure 6-5: Global Tab

6.4.2 Dry and Wet Inputs

There are four dry contact discrete inputs and four wet contact discrete inputs on the analyzer. The *Inputs-WET* tab (Figure 6-6) and *Inputs-DRY* tab are identical and allow the operator to configure these discrete inputs in any manner. These inputs can be configured to trigger a certain type of run, or to monitor external pressure or temperature switches, for example. A detailed discussion of these Input tabs is presented in Section 5.11 and 5.12.

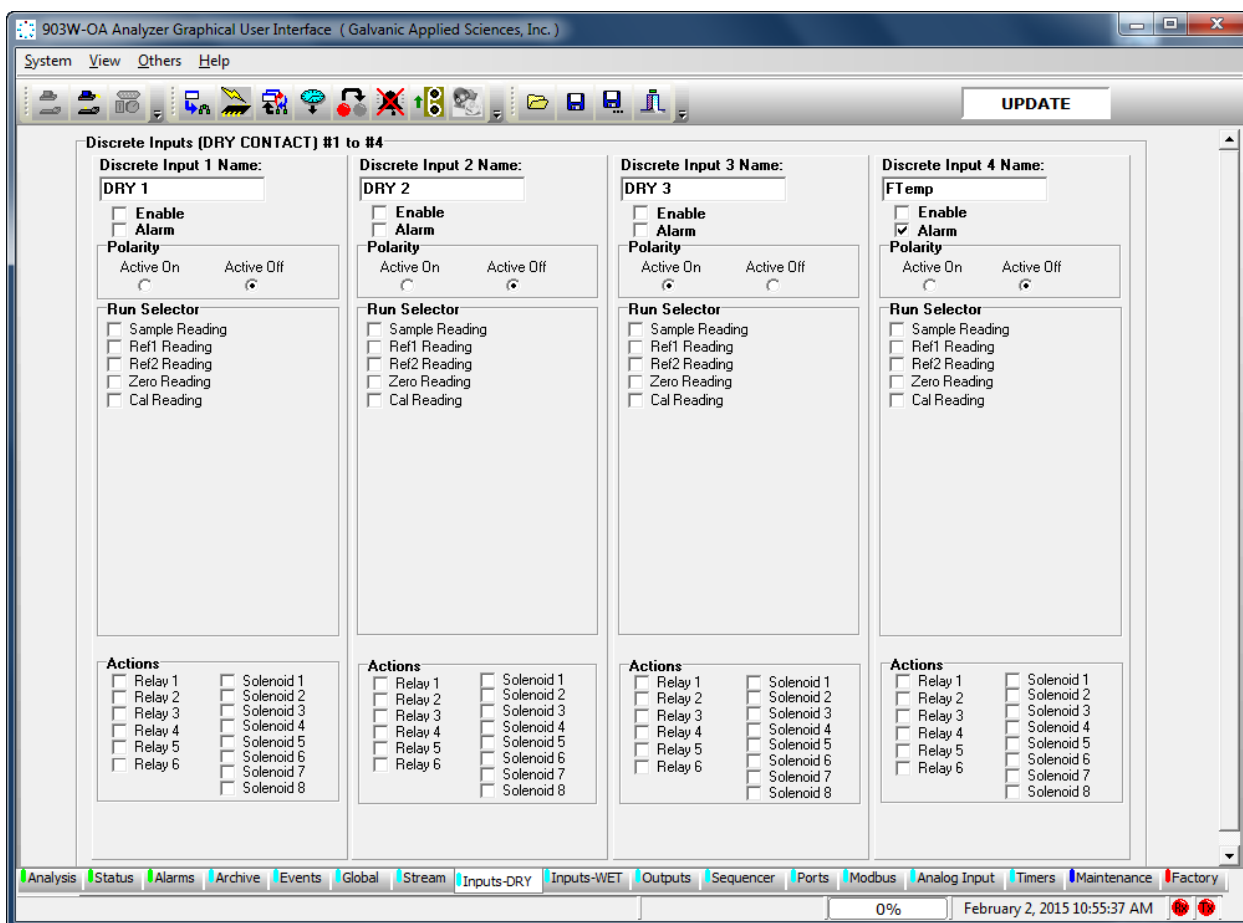

Figure 6-6: Input-Dry Tab

6.4.3 Outputs Tab

The *Output* tab (Figure 6-7) allows the user to configure the behaviour of the 6 onboard relays and 8 solenoids. In addition, it is where the analog outputs are named and configured. The tab is divided into 2 main sections: *Digital Output* and *Analog Outputs*. A detailed discussion of the *Outputs* tab is presented in Section 5.13.

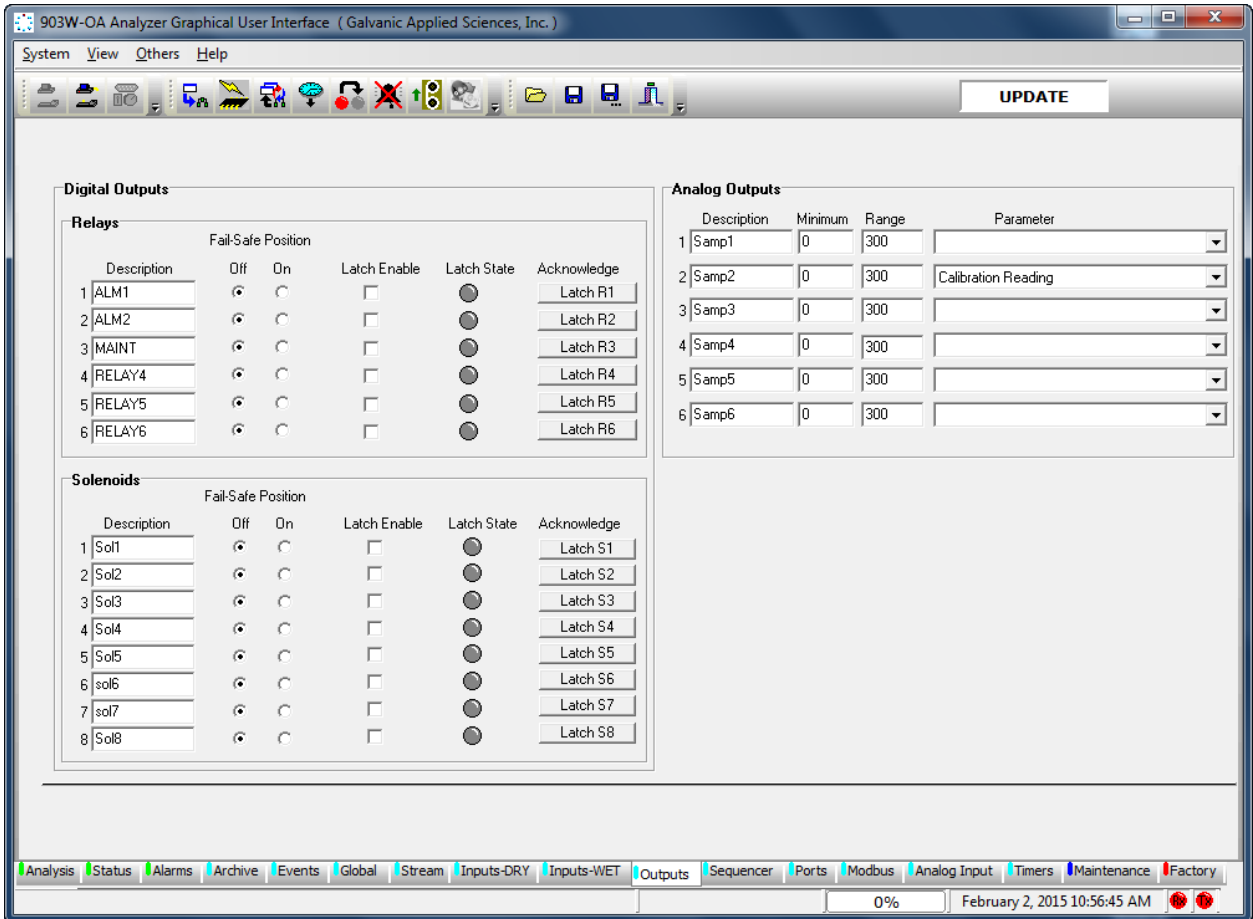

Figure 6-7: The Outputs Tab

6.4.4 The Ports Tab

The *Ports* tab (Figure 6-8) shows the configuration of the 3 main communications ports on the analyzer - the Front Panel Serial Port (RS-232), the ISO 485 Port (RS-485), and the MODEM Port (RS-232). A detailed discussion of the *Ports* tab is presented in Section 5.15.

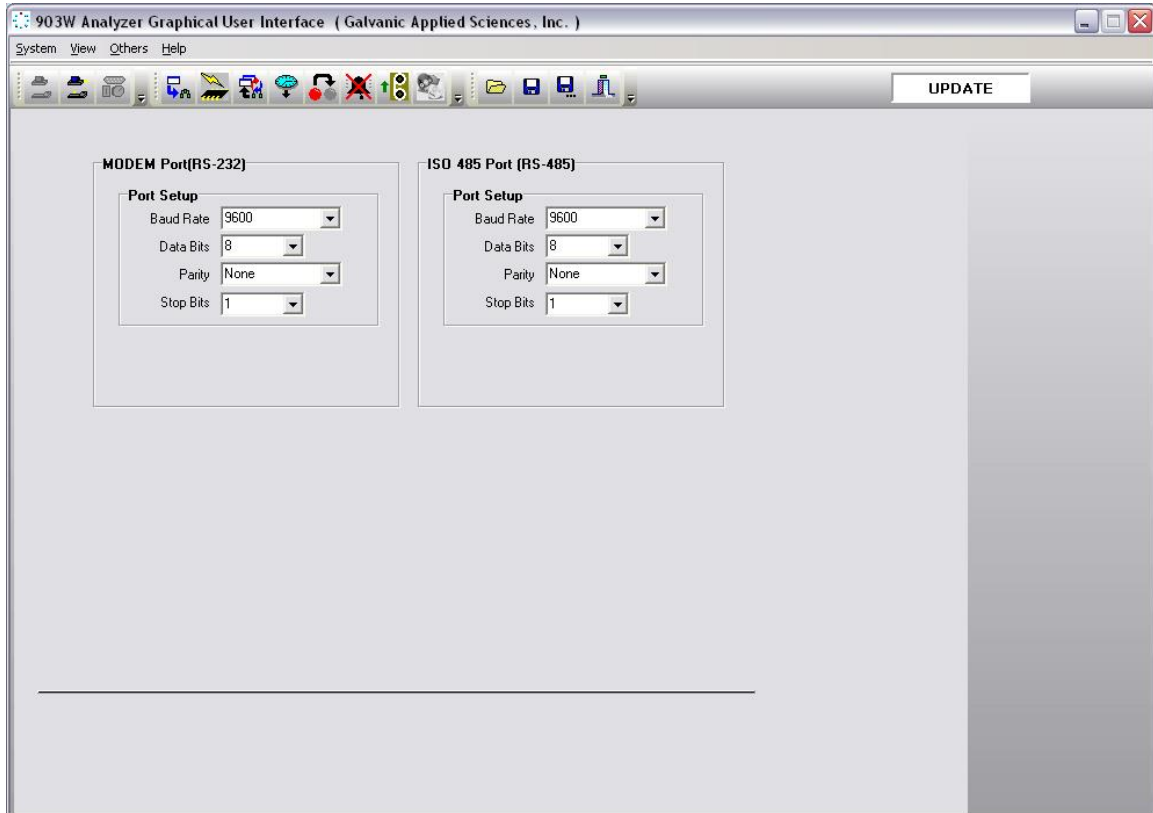

Figure 6-8: The Ports Tab

6.4.5 Modbus Tab

The *Modbus* tab (Figure 6-9) allows the user to set up the analyzer to output data in 3 varieties of MODBUS communication protocol - Enron, Modicon 16, and Modicon Floating Point. As there are a large number of possible configurations for Modbus, and every user may desire a slightly different configuration, this manual will only cover the basics of Modbus configuration. If the user requires assistance in setting up a Modbus configuration, the Service department at Galvanic Applied Sciences Inc. will assist in configuring the unit as desired. A detailed discussion of the Modbus tab is presented in Section 5.16.

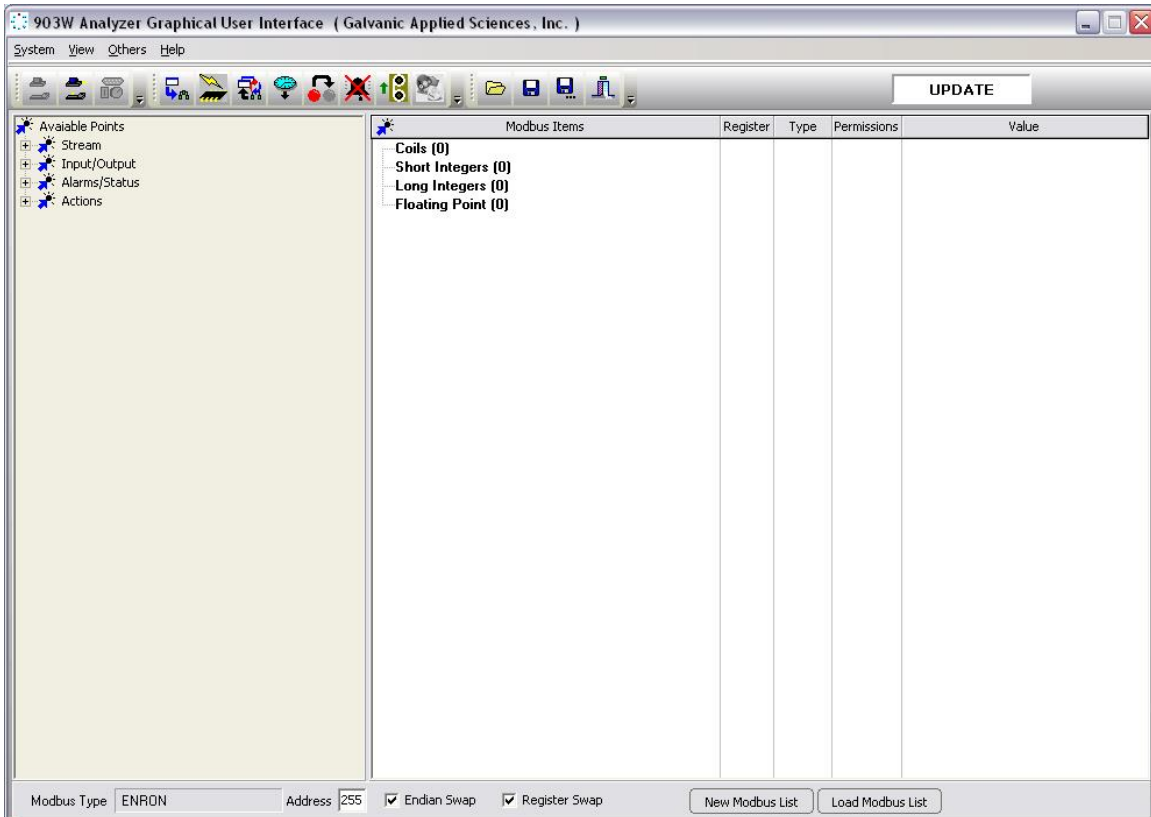

Figure 6-9: The Modbus Tab

6.4.6 Timers Tab

The *Timers* tab (Figure 6-10) offers another powerful way to trigger conditional gas run requests other than the ones on the *Streams* Tab. Manual Sequences can also be triggered using start and stop timer set points. A detailed discussion of the *Timers* tab is presented in Section 5.18.

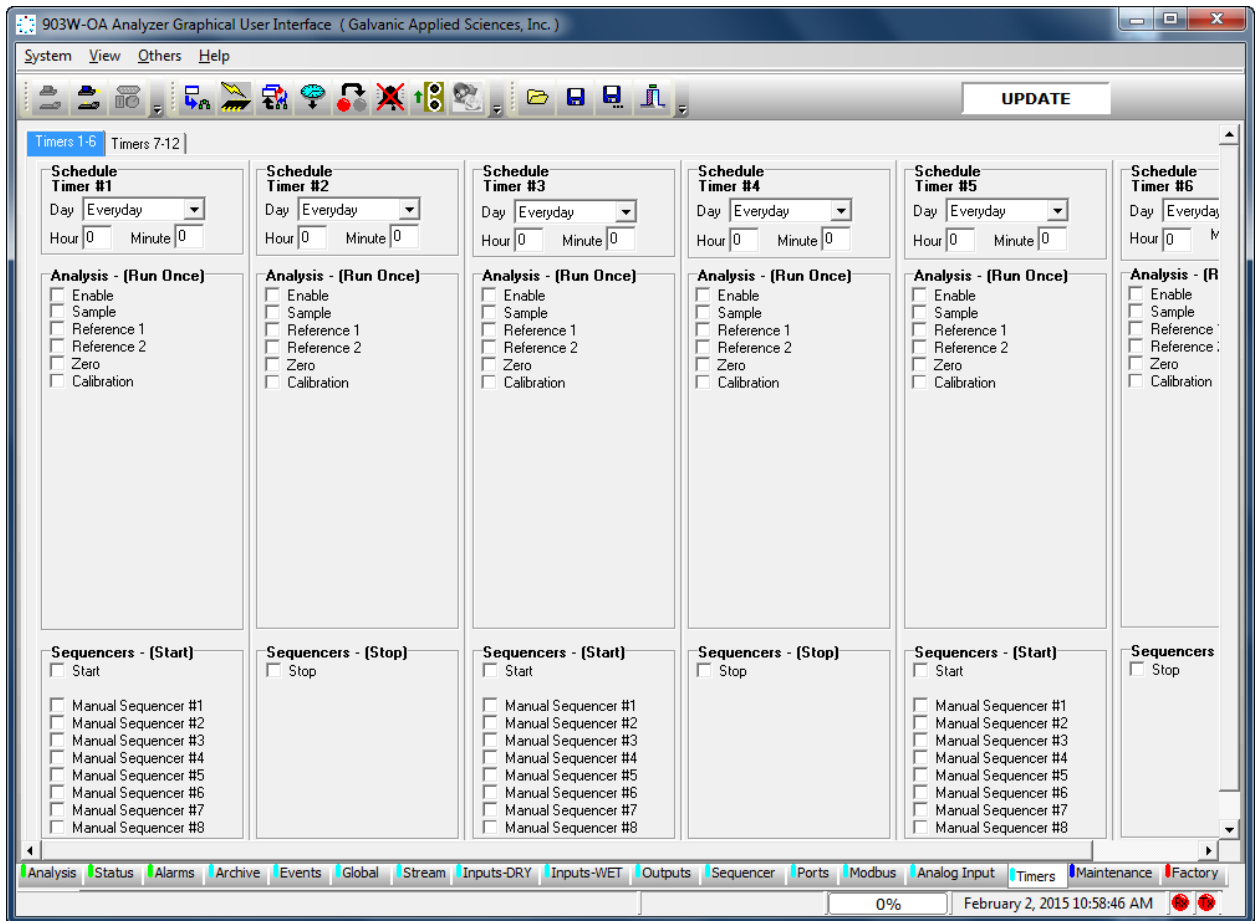

Figure 6-10: Timers Tab

6.5 Calibrating/Validating the Analyzer Outputs

The *Maintenance* tab (Figure 6-11) is used to manually manipulate the analyzer's outputs. Analog output loop test can be performed by using the *Analog Output Test* feature to deliver 0, 25, 50, 75 and 100% of full scale or any other test values. The outputs can also be adjusted by using the Analog Output X Calibration feature. A detailed discussion of the *Maintenance* tab is presented in Section 5.19.

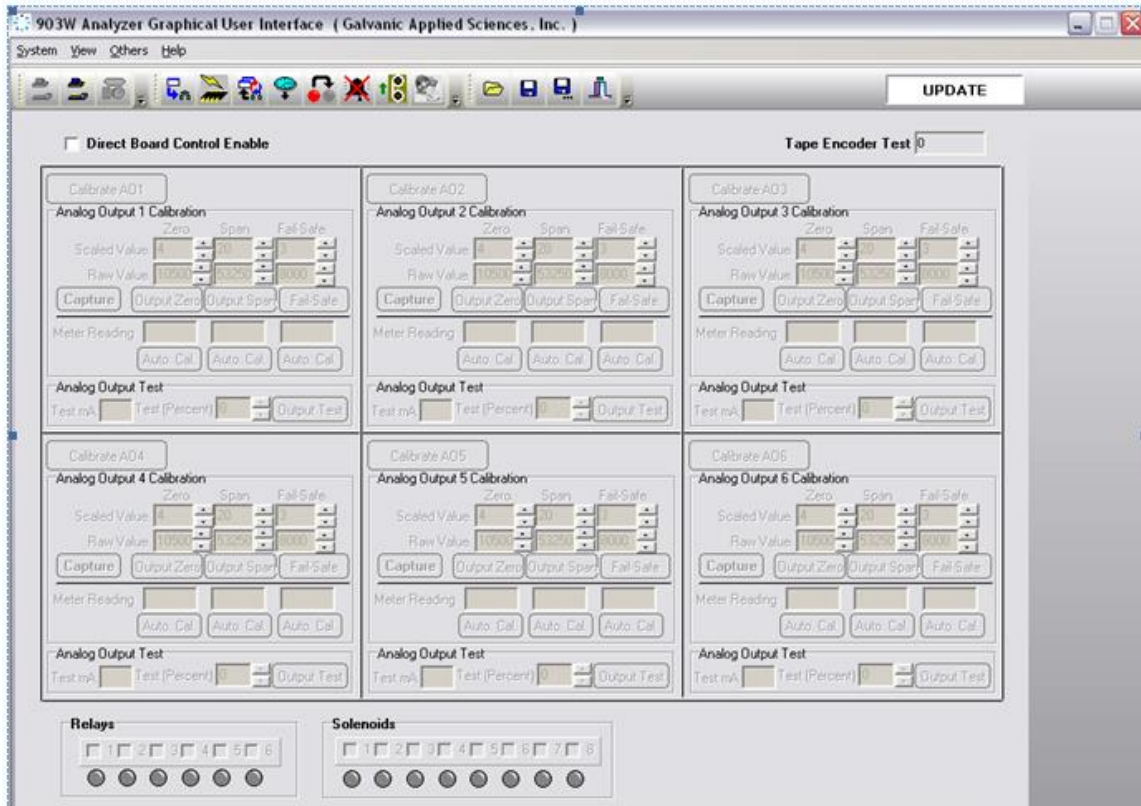

Figure 6-11: Maintenance Tab

6.6 Calibrating/validating the Analyzer

The analyzer must be calibrated using known certified standards. The concentration of the calibration gas should be 50 - 75 % of the analyzer's full scale.

The analyzer can be calibrated 3 ways:

- a) Manual Calibration (Section 6.6.1)
- b) Manually Initiated Auto Calibration (Section 6.6.2)
- c) Auto Calibration (Section 6.6.3)

6.6.1 Manual Calibration

NOTICE

The analyzer must be equipped with a manually operated 3-way valve that can be used to introduce calibration gas to the analyzer.

- a) Place the analyzer in *Bypass* mode by pressing the *Bypass* button on the handheld keypad. This will disable any alarm outputs.
- b) Connect the calibration gas to the Calibration port of the analyzer and set the output pressure of the calibration standard to the same pressure that the sample gas normally runs at (this is typically 15 psig).
- c) At this point the analyzer will be running its auto sequence. If calibration gas is introduced all outputs and data logs will be updated with information that is generated while the calibration gas is running. If this is not desired, place the analyzer in Reference Mode. While the analyzer is in Reference Mode, any data will be logged as Reference data, not as stream data. To place the analyzer in reference mode, using the GUI software to initiate the Reference 1 Manual sequence.

NOTICE

If the analyzer is to be calibrated while the analyzer is still running the auto sequence, it is important to disable the High High alarm if the calibration gas is higher than the alarm setpoint.

- d) Turn the 3-way valve to introduce calibration gas to the analyzer.
- e) Allow the analyzer to analyze the calibration gas until the readings become stable. This typically takes 15 to 30 minutes. Once the readings become stable, make a note of the current analyzer reading.
- f) To calibrate the analyzer, an adjustment must be made to the analyzer's *Gain Factor*. The gain factor can be found on the Streams tab of the GUI as well as on the hand held keypad. The new Gain Factor can be calculated by formula shown in Equation 6-1.:

New Gain = (Calibration Gas Value / Current Analyzer Reading) × Current Gain Factor 6-1

The *Global* tab has a Gain Calculator where the user can enter the Calibration Gas Value, the Analyzer reading and the current Gain Factor. The calculator will calculate the value for the new gain; however, the user will still have to enter it in the GUI or through the keypad.

- g) Once the new gain is entered, the analyzer is calibrated. Allow the analyzer to run one or two more cycles to verify that the analyzer is reading correctly.
- h) Turn the 3 way valve back to process gas. Allow the analyzer reading to stabilize on the process gas.
- i) If the analyzer was placed in *Reference* mode, then disable the Manual Sequencer so that the analyzer will return to its normal auto sequence.
- j) Press the *Bypass* button on the keypad to take the analyzer out of Bypass mode so that any alarm outputs will be re-activated.

6.6.2 Manually Initiated Auto Calibration

The analyzer must be equipped with a manually operated 3-way valve that can be used to introduce calibration gas to the analyzer.

- a) Place the analyzer in Bypass by pressing the *Bypass* button on the handheld keypad. This will disable any alarm outputs.
- b) Connect calibration gas to the *Calibration* port of the analyzer. Set the output pressure of the calibration standard to the same pressure that the sample gas normally runs at (this is typically 15 psig).
- c) Turn the 3-way valve to introduce calibration gas to the analyzer.
- d) Enter the value of the calibration standard in the *Calibration* tab of the *Streams* tab of the GUI.
- e) Initiate an *Auto* calibration run, either from the GUI or from the keypad.
- f) The analyzer will run the Auto Calibration according to the setup of the Stream/Calibration run. The analyzer will run the total number of runs defined by *Consecutive Runs*. It will then average the number of results together as defined by "Runs to Average". A new Gain Factor will be automatically calculated using the calibration gas value defined in *Cal.Gas Concentration*.
- g) When the Auto calibration is complete the analyzer will automatically return to the previously defined automatic sequence.
- h) When the calibration is complete, turn the 3 way valve back to process gas.
- i) Press the *Bypass* button on the keypad to take the analyzer out of Bypass mode so that any alarm outputs will be re-activated.

6.6.3 Auto Calibration

NOTICE

The analyzer must be equipped with a 3 way solenoid valve that is controlled by the analyzer and is used to introduce calibration gas to the analyzer.

- a) Initiate an Auto Calibration run, either from the GUI or from the keypad. The Auto Calibration can be initiated from the GUI by pressing the “Stream 1 Calibration” button as shown in Figure 6-12. Alternatively, the Auto Calibration process can be initiated from the keypad by pressing F1 STRM, then using the F4 and F3 keys to scroll down to CAL. It will currently indicate that the status is OFF. Press the EDIT key on the keypad and press the ENTER key to toggle the value to ON.

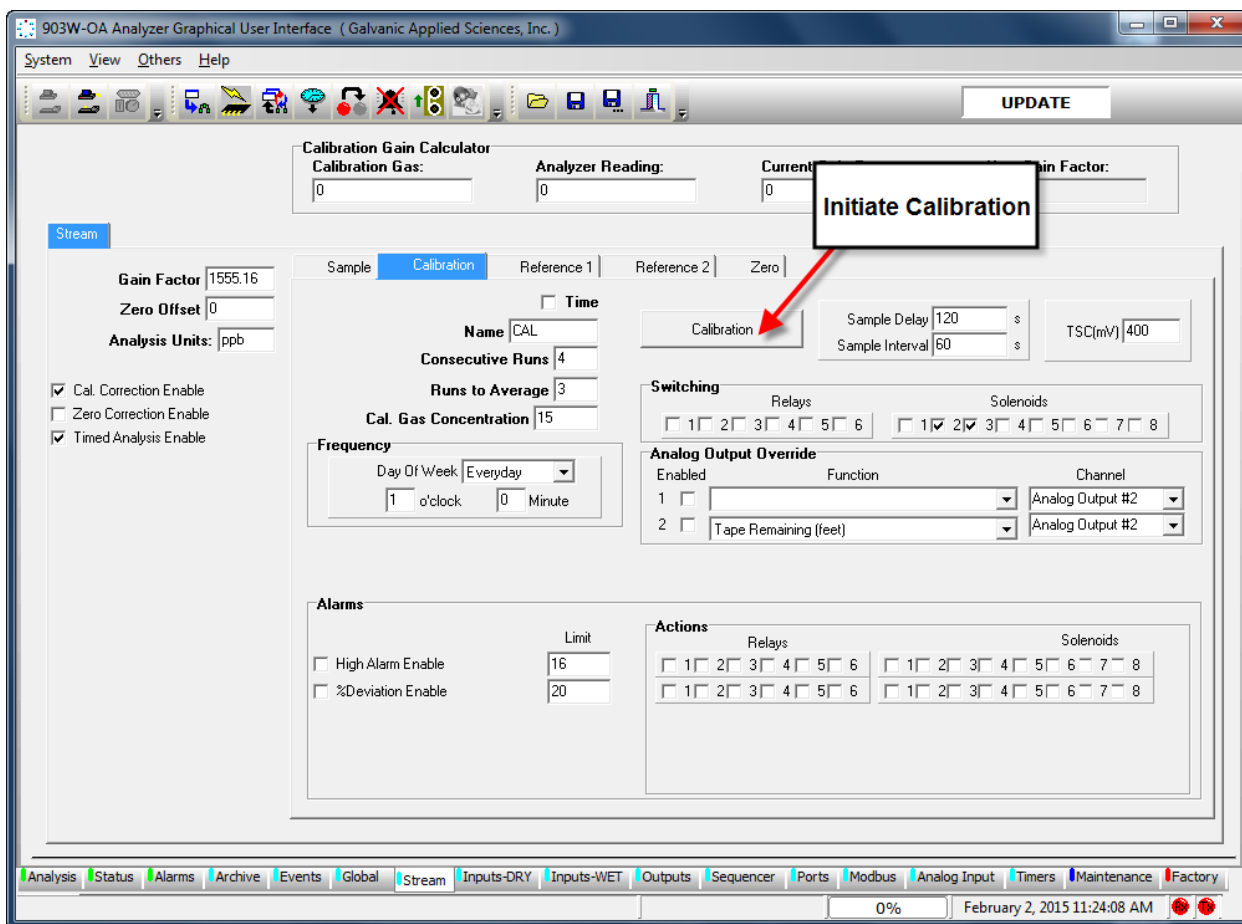

Figure 6-12: Initiate Stream Calibration

- b) The analyzer will run the Auto Calibration according to the setup of the Stream/Calibration run. The analyzer will run the total number of runs defined by *Consecutive Runs*. It will then average the number of results together as defined by *Runs to Average*. A new Gain Factor will be automatically calculated using the calibration gas value defined in *Cal. Gas Concentration*.
- c) When the Auto Calibration is complete the analyzer will automatically return to the previously defined automatic sequence.

NOTICE

When an Auto Calibration is initiated, either from the GUI or from the keypad, the analyzer will finish the current analysis cycle before it begins the calibration cycle.

6.7 Analyzing Samples

The operation of the system is governed by the data on the *Sequencer* or *Timers* tab and the analyzer can be operated on a manual or automated basis. The Analysis tab (Figure 6-13) is a live presentation of the analytical data and allows the operator to see the status of many facets of the analyzer all at a glance. The GUI polls the analyzer every 3 seconds, causing this information to be updated continuously. A detailed discussion of the *Analysis* tab is presented in Section 5.4.

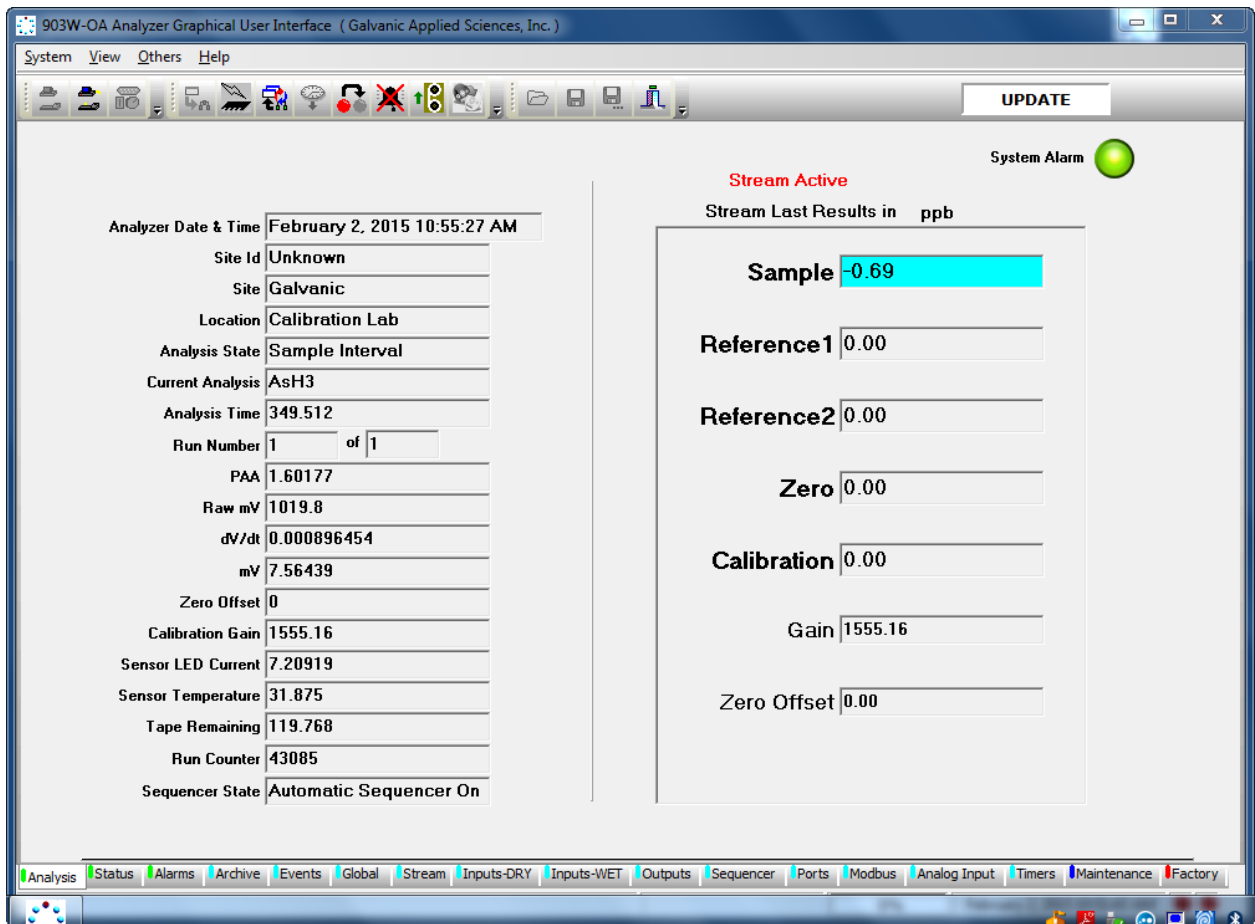

Figure 6-13: The Analysis Tab

All data is stored in the computer that is onboard the analyzer and can be retrieved as desired using the *Archive* tab (Figure 6-14). A detailed discussion of the *Archive* tab is presented in Section 5.7.

Archive: On Run 11438 Records Available. Display the last 15 Records. Log Setup

Read Archive from Analyzer
Read Archive from File
Graph Selected Column

Seq	Log Name	Timestamp	Live						
11424	On Run	10/08/2007 09:32:53	-0.0186478						
11425	On Run	10/08/2007 09:36:00	1.44170868						
11426	On Run	10/08/2007 09:39:08	0.30974787						
11427	On Run	10/08/2007 09:42:15	0.00294764						
11428	On Run	10/08/2007 09:45:22	0.39558964						
11429	On Run	10/08/2007 09:48:30	-0.0138876						
11430	On Run	10/08/2007 09:51:37	-7.8469514						
11431	On Run	10/08/2007 09:54:44	-0.0403111						
11432	On Run	10/08/2007 09:57:52	0.49382102						
11433	On Run	10/08/2007 10:00:59	-0.0122553						
11434	On Run	10/08/2007 10:04:06	-0.0308933						
11435	On Run	10/08/2007 10:07:14	-0.0139358						
11436	On Run	10/08/2007 10:10:21	-0.0293199						
11437	On Run	10/08/2007 10:13:28	0.00856544						
11438	On Run	10/08/2007 10:16:35	1.87335240						

Figure 6-14: The Archive Tab

NOTICE

To extract data from the log, press the *Read Archive from Analyzer* button. Alternatively, a previously saved archive record can be loaded by pressing the *Read Archive from File* button. The archive on the analyzer is quite large, so retrieving data from the archive can take several minutes, especially if the PC is connected to the analyzer via a serial connection. Once the data has been retrieved, the user will be prompted to choose a directory and a file name for the archive data to be saved to.

If desired, the data can be viewed in a graphical format (Figure 6-15).

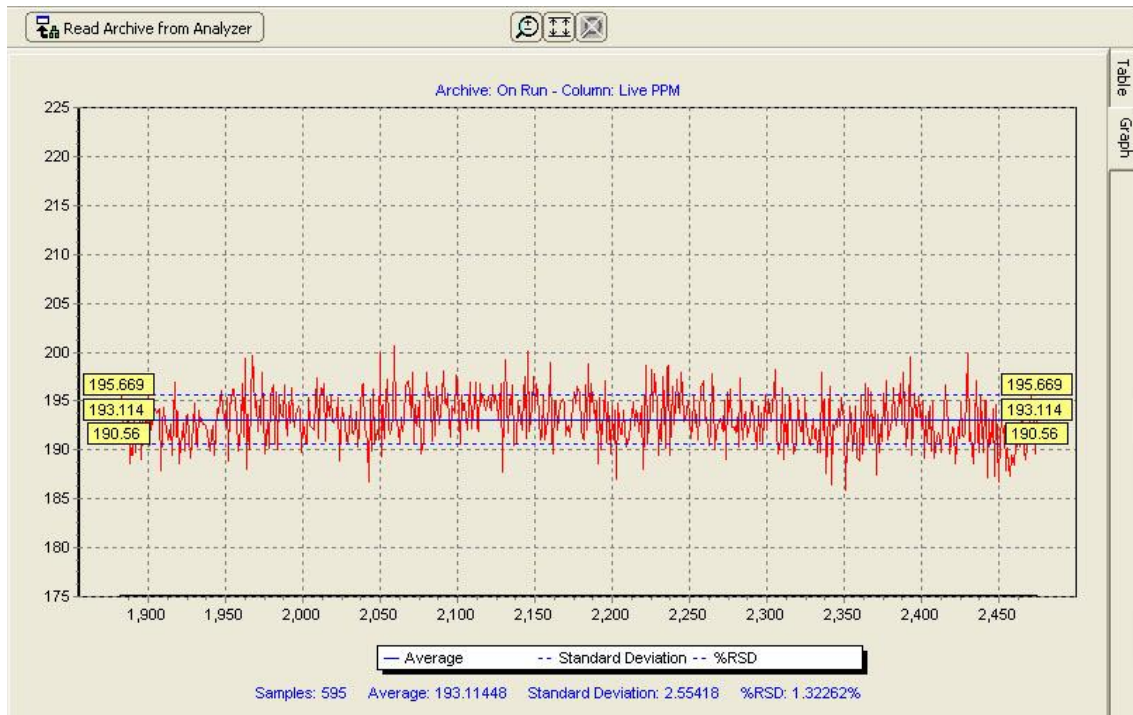

Figure 6-15: Graphic Data

6.8 Monitoring System Operation

The *Event* tab (Figure 6-16) presents a log of all operations that occur during operation and is a useful way to monitor the system. It tracks all alarm conditions experienced by the analyzer, both global and stream related, but also such things as changes in configuration and power up events. A detailed discussion of the *Event* tab is presented in Section 5.8.

Event Log Records:					Read from Analyzer
Seq	Timestamp	Event	Alarm	State	
1	23/03/2007 15:00:41	Power Up	No Alarm	Condition On	
2	23/03/2007 15:06:48	Alarm	Sensor LED Current	Condition On	
3	23/03/2007 15:14:00	Power Up	No Alarm	Condition On	
4	23/03/2007 15:19:17	Power Up	No Alarm	Condition On	
5	23/03/2007 15:31:54	Power Up	No Alarm	Condition On	
6	23/03/2007 16:07:01	Power Up	No Alarm	Condition On	
7	26/03/2007 09:13:26	Alarm	Stream 1 PAA	Condition On	
8	26/03/2007 09:14:31	Alarm	Stream 1 PAA	Condition Off	
9	26/03/2007 09:20:21	Power Up	No Alarm	Condition On	
10	26/03/2007 10:18:31	Configuration Changed	No Alarm	Condition On	
11	26/03/2007 10:26:31	Configuration Changed	No Alarm	Condition On	
12	26/03/2007 10:27:51	Configuration Changed	No Alarm	Condition On	
13	26/03/2007 10:28:34	Alarm	Stream 1 PAA	Condition On	
14	26/03/2007 10:29:53	Alarm	Stream 1 PAA	Condition Off	
15	26/03/2007 10:29:55	Configuration Changed	No Alarm	Condition On	
16	26/03/2007 10:36:34	Alarm	Stream 1 Normal Alarm 1	Condition On	
17	26/03/2007 10:37:54	Configuration Changed	No Alarm	Condition On	
18	26/03/2007 10:38:54	Alarm	Stream 1 Normal Alarm 1	Condition Off	
19	26/03/2007 11:06:47	Alarm	Stream 1 Normal Alarm 1	Condition On	
20	26/03/2007 11:32:58	Alarm	Stream 1 Normal Alarm 1	Condition Off	
21	26/03/2007 11:32:58	Configuration Changed	No Alarm	Condition On	
22	26/03/2007 12:08:29	Configuration Changed	No Alarm	Condition On	

Event Log Memory Usage: 0.25%

Figure 6-16: The Events Tab

The *Alarms* tab (Figure 6-17) allows the operator to view the status of most of the enabled analyzer alarms. A detailed discussion of the Alarms tab is presented in Section 5.xx.

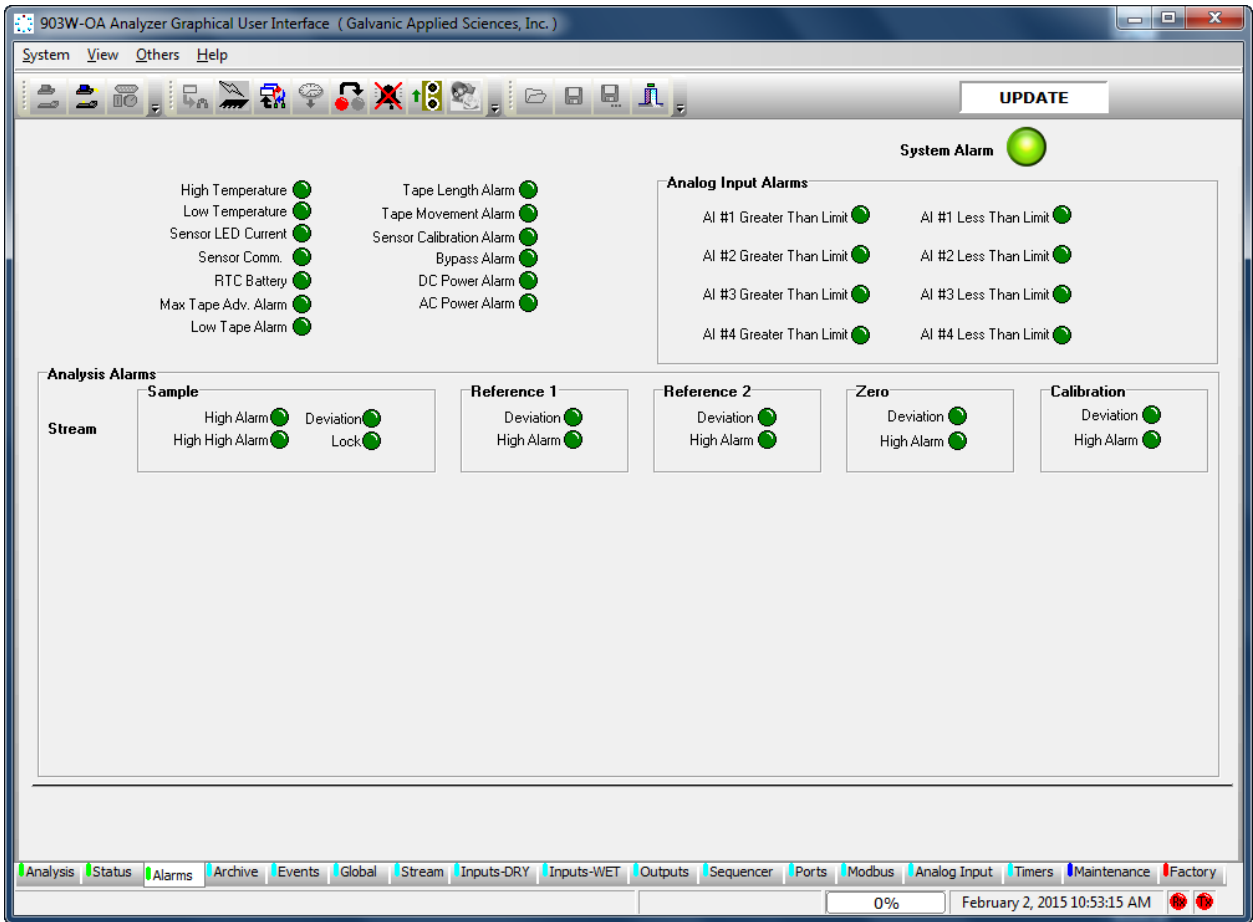

Figure 6-17: The Alarms Tab

The *Status* tab (Figure 6-17) gives the operator the current status of the: analog outputs, relays, solenoids, Analog inputs, Discrete inputs, and what voltage input source is in use. In some cases the activation or deactivation of the status indicators may suggest there is an alarm associated with it. A detailed discussion of the *Status* tab is presented in Section 5.5.

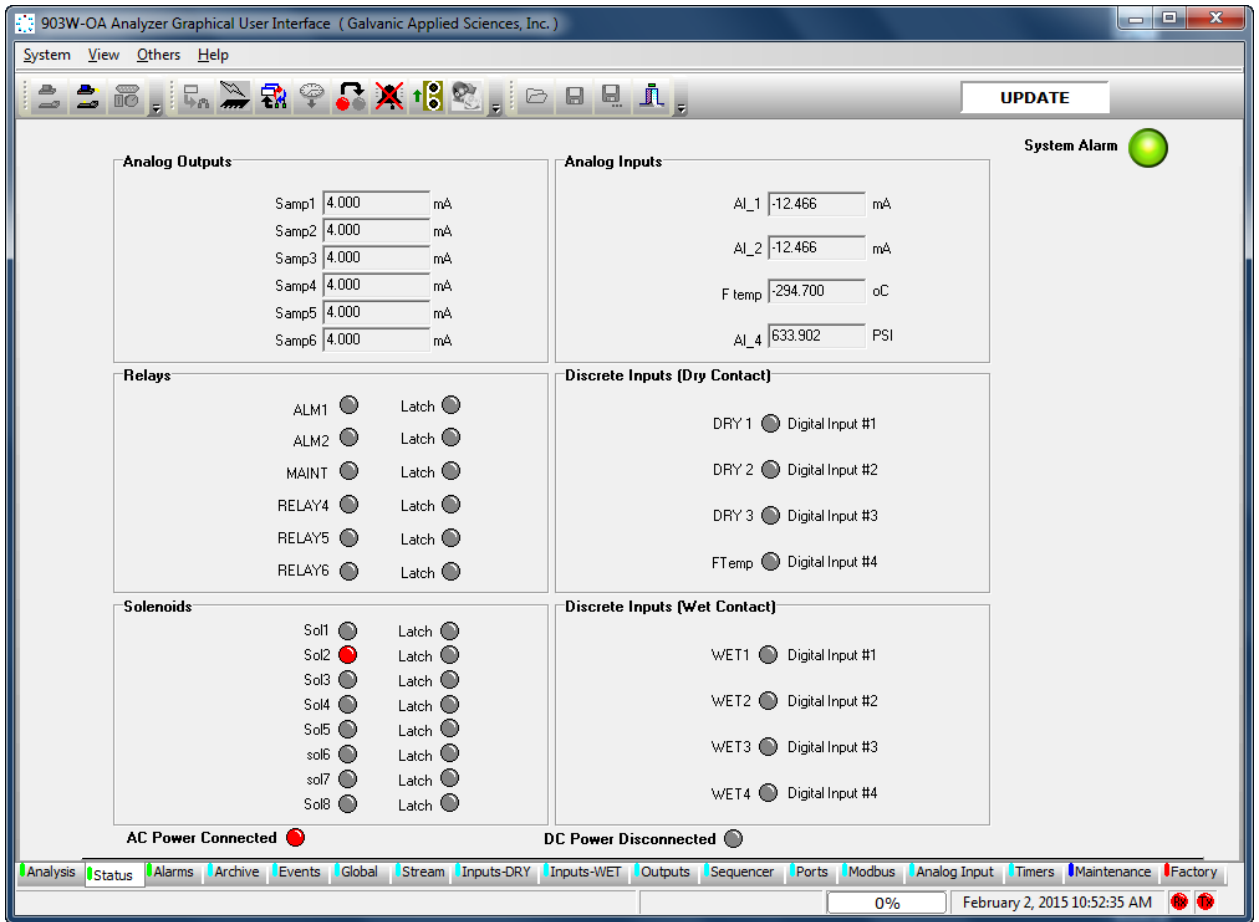

Figure 6-18: Status Tab

Section 7 **Maintenance**

7.1 Overview

The analyzer is designed for automatic trouble-free operation under the continuous supervision of the internal computer. As described in Sections 4 and 5, a series of alarms are presented on the hand held keypad and the GUI if an operation or function is not performing in the appropriate manner to alert the user that a problem exists. A detailed discussion of service protocols is presented in Section 8.

Routine Preventative Maintenance of the analyzer consists of a periodic performance of the *Maintenance Check-out Procedure* (Section 7.2). Routine maintenance will correspond to tape usage, which is 4 - 6 weeks for most applications.

On a periodic basis, it will be necessary to replace certain components of the system such as the sensing tape and the filter element. Replacement procedures for these items are described in Section 7.3-7.6.

7.2. Routine Maintenance Procedures

- a) Check display for any alarms (press *F2* on keypad). See Section 8 for information about resolving any active alarms
- b) Disable alarms by pressing the *BYPASS* button.
- c) Turn off gas to the analyzer. Pull back the Compression Head and inspect the Sample Chamber for paper dust and dirt. If required remove the Sample chamber assembly and clean (see Section 7.3).
- d) Change tape and ensure the tape is re-inserted properly (see. Section 7.3).
- e) Advance tape with *TAPE ADV* key.
- f) Check for proper take-up.
- g) Top up the level of the water solution to the red line (see Section 7.7).
- h) Re-calibrate the sensor. Press *F4 (MNT)* on the keypad, then press *F1*. Press *F4* to scroll down the screens to *SenCal*. Press the *EDIT* key and press the *ENTER* key to toggle the parameter to ON. The sensor will calibrate and then automatically go online.
- i) Check the mV reading is 0 mV +/- 10 mV at the start of the cycle.
- j) Reset the tape length to 300 ft through the keypad. (*F4*, *F1*, press the *EDIT* key then enter the value of 300 and press the *ENTER* key)
- k) Check the sample system as described in Sections 7.4 and 7.5

7.3 Changing the Tape

The sensing tape is consumed during the measurement process and must be replaced on a periodic basis. The amount of tape remaining is indicated on the *Analysis* screen of the GUI and the *GEN* menu on the hand held controller. In addition, an alarm will be presented on the *Alarms* tab of the GUI and the hand held controller when the tape level is low.

To replace the tape:

- a) Check the hand held display for any alarms.
- b) Disable alarms by pressing the *BYPASS* button on the hand held controller
- c) Turn off gas to the analyzer. Pull back the Compression Head and inspect the Sample Chamber (Figure 7-1) for paper dust and dirt. If necessary, remove the Sample chamber assembly and clean it.

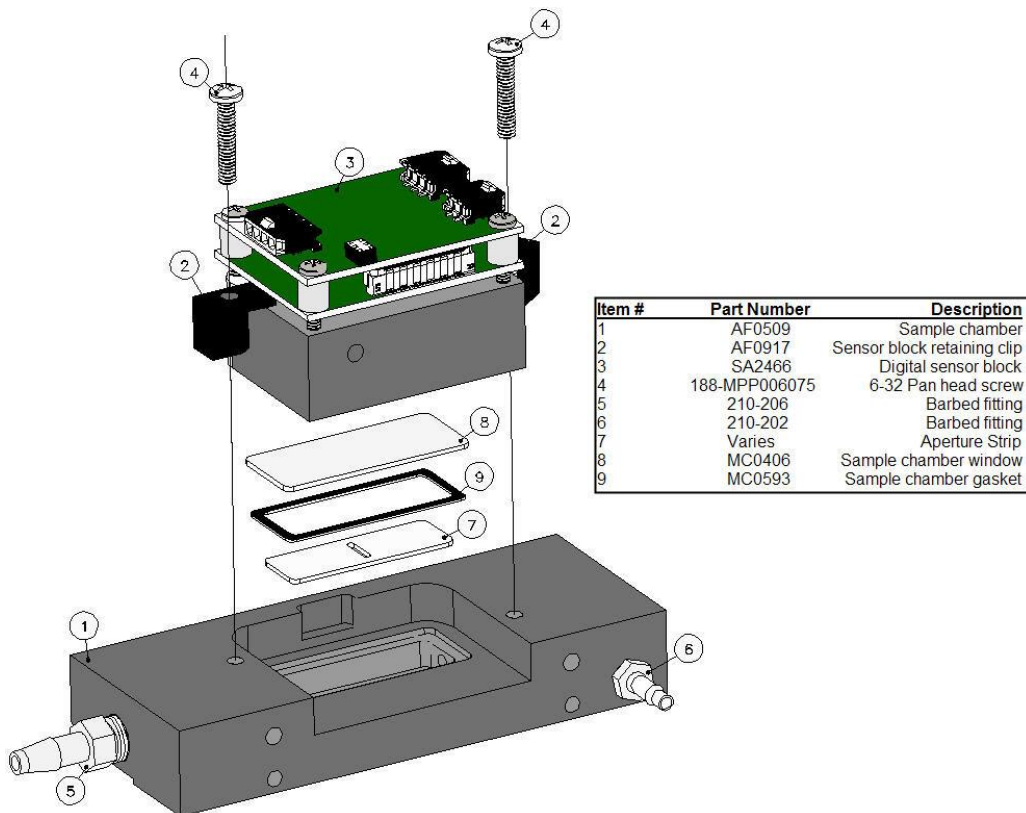

Figure: 7-1: Sample Chamber Assembly

- d) Remove the tape cover from the left side of the chassis to view the tape enclosure. Figure 7-2 presents the open enclosure with various components identified.
- e) Remove the screw-on disks (not shown) from the supply reel (1) and take-up reel (2).
- f) Take a new reel of tape and remove the adhesive tape securing the end. Place the tape reel on the supply reel. Make sure the tape is installed so that the loose end hangs down on the left side of the reel, not the right.
- g) Thread the tape over the lower sample chamber guide pin (3). Push the compression head (4) back and slide the tape behind the compression head. Ensure that the tape is flat against the groove in the sample chamber (8) and has no creases.

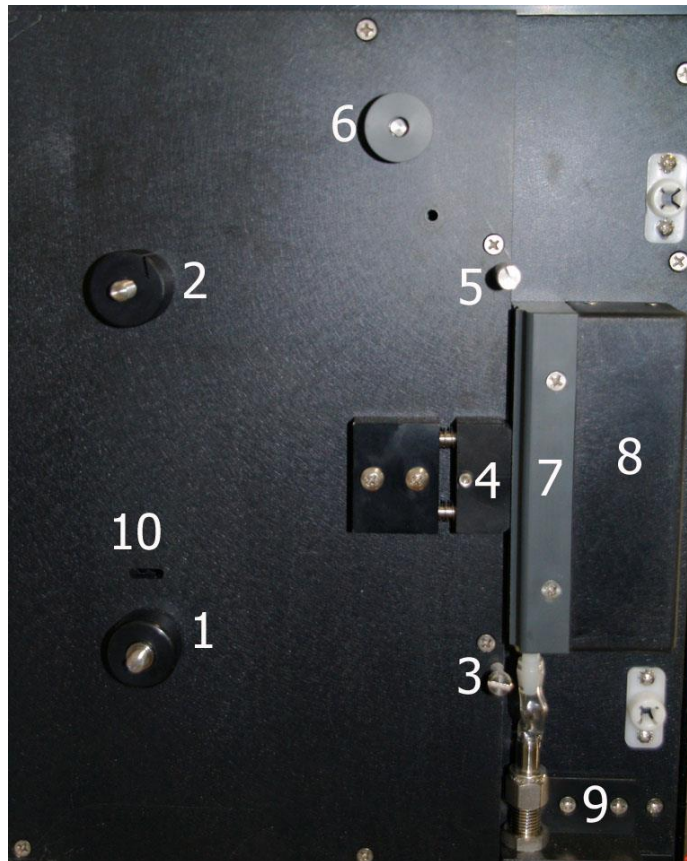

Figure 7-2: Tape Enclosure Parts Reference

- h) Pull the tape up over the upper sample chamber guide pin (5).
- i) Thread the tape over the black aluminium / grey plastic capstan of the pulse counter (6). (Note that this capstan may be either aluminium or plastic).
- j) Fold over the first inch of the tape, and then slide this folded end of the tape into the slot on the take-up reel (2), as shown in Figure 7-3.

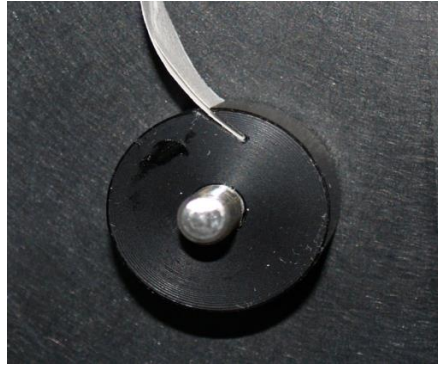

Figure 7-3: Insertion of Tape End into Take-up Reel

- k) Replace the screw-on disks onto the supply and take-up reel. The larger disk goes on the take-up reel.
- l) Take up any slack in the tape by rotating the tape reel on the supply reel clockwise until the tape is tight.

The correct installation of tape on the analyzer is shown in Figure 7-4. The image on the left shows the completed tape installation without the anti-coning disks and the one on the right shows the tape installation with the disks.

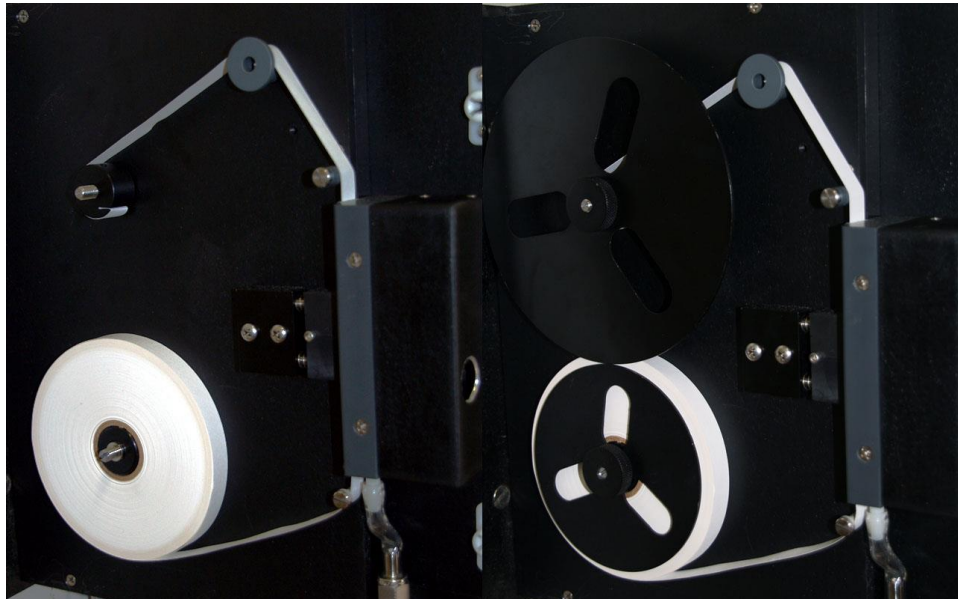

Figure 7-4: Installation of Sensing Tape

- m) Advance tape a few inches with the *TAPE ADV* key.
- n) Check the tape for proper take-up.

- o) Re-calibrate the sensor by selecting the *Sens* on the GEN menu using the key pad. Press the EDIT key and press ENTER key to toggle the parameter to ON. The sensor will calibrate and then automatically go online.
- p) Check that the mV reading is 0 mV +/- 10 mV at the start of the cycle.
- q) Reset the tape length to 300 ft through the keypad.

7.4 Checking the Sample System

On a periodic basis, the sampling system should be inspected and cleaned to ensure an optimum flow of sample gas to the analyzer.

To check the sampling system:

- a) Turn off gas supply and block valves
- b) Check the filter element - replace if required
- c) Check that the sample pressure is set at 15 psig
- d) Check sample flow on the chassis flow meter is somewhere between 1.5 and 2.0 on the tube scale

Section 8 **Troubleshooting and Service**

8.1 Overview

The *Service* section consists of procedures for determining the cause of a problem and includes a series of procedures to replace certain components.

A major component failure should be handled by contacting Galvanic Applied Sciences, Inc. Galvanic Applied Sciences, Inc. offers service on a call-out basis and/or factory assistance on the analyzer.

For Service and/or Assistance Contact:
Galvanic Applied Sciences Inc.
7000 Fisher Road SE
Calgary, Alberta T2H 0W3
Canada

Tel: 403-252-8470
TOLL FREE (CANADA/US): 1 (866) 252-8470
Fax: 403-255-6287
Email: info@galvanic.com

For service emergencies, please phone our 24 hour technical support cell phone at 1 (403) 651-0344.

8.2 Troubleshooting Messages and Alerts

The *Alerts* tab of the application program and the *Alarms* tab of the handheld keypad provide a broad range of warnings about difficulties with the system. A list of the messages is presented in Table 8-1

Table 8-1: Alarms

General System Alarms	High Temperature Alarm Low temperature Alarm Sensor LED Current RTC Battery Max Tape Advance Alarm Low Tape Alarm Tape Length Alarm Tape Movement Alarm Sensor Calibration Alarm Bypass DC Power Alarm AC Power Alarm
Analog Input Alarms	AI#1 > Limit AI#1 < Limit AI#2 > Limit AI#2 < Limit AI#3 > Limit AI#3 < Limit AI#4 > Limit AI#4 < Limit
Analysis Alarms - Sample	High Alarm High High Alarm Deviation Lock
Analysis Alarms - Reference 1	High Alarm High High Alarm Deviation Lock
Analysis Alarms -Reference 2	High Alarm High High Alarm Deviation Lock
Analysis Alarms – Zero ¹	High Alarm High High Alarm Deviation Lock
Analysis Alarms – Calibration	High Alarm High High Alarm Deviation Lock

The *Events* tab (Section 5.8) keeps track of all of the various conditions (alarms, power on/off, configuration changes, discrete input conditions, etc) that occur as the analyzer runs. The *Event* log is primarily used as a troubleshooting aid. If issues start occurring with the analyzer, looking at the *Event* Log can help to track down the source of the issue. The *Event* Log also gives a record of the types of alarms that have occurred during operation of the analyzer, and when exactly they occurred. To obtain a full list of all of the Event Log records from the analyzer, simply press the *Read from Device* button at the top of the screen.

8.3 Alarms Tab

The top left side of the *Alarms* tab (Figure 8-1) are global alarms defined in Table 8-2. These non-analysis related alarm parameters affect all streams identically and are related to hardware and other physical parameters that affect the operation of the analyzer. In many cases, the set point for these global alarms is user configurable. Each alarm can be configured to a) be active or not active and b) to trigger certain outputs, either solenoids or relays.

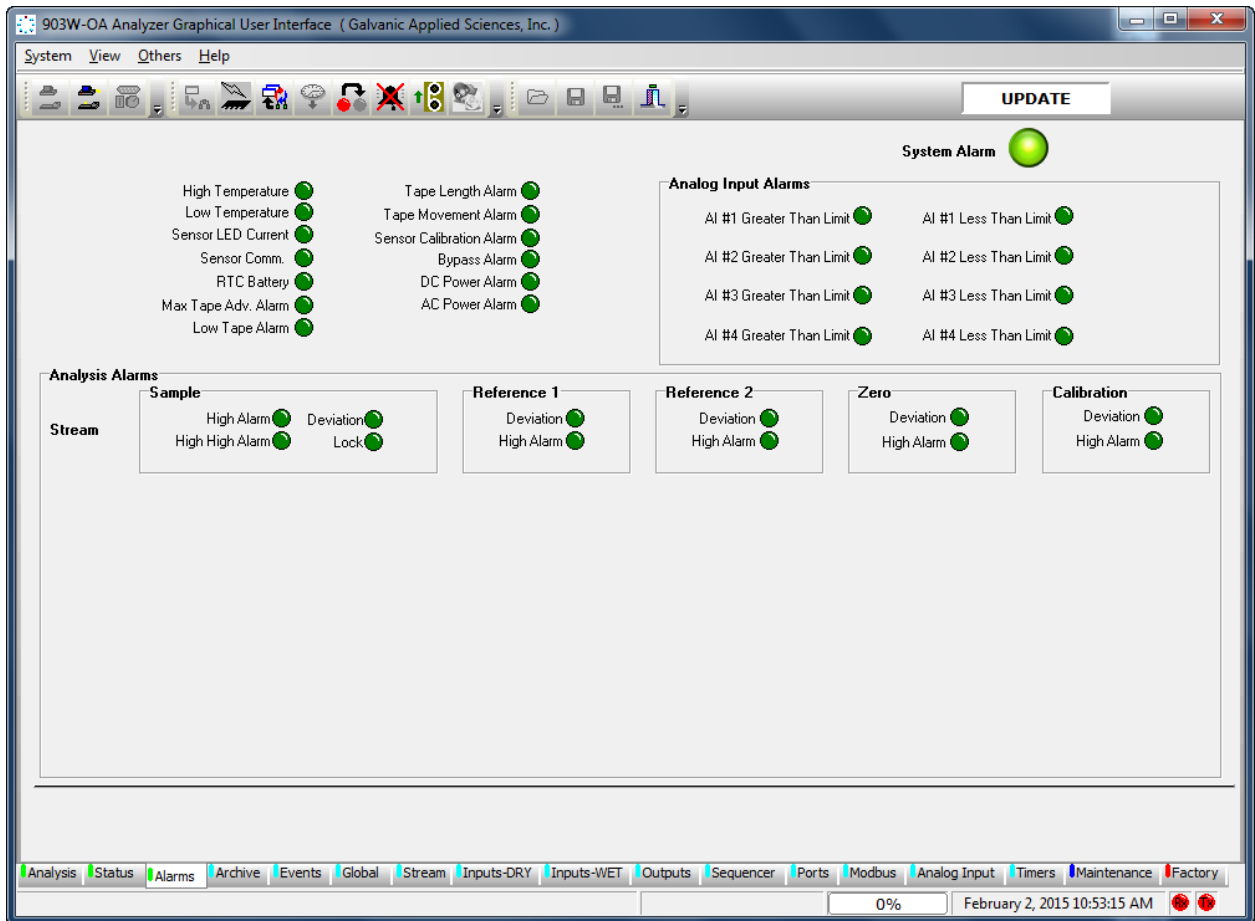

Figure 8-1: Alarms Tab

Table 8-2: Alarms

High Temperature	Triggered if the temperature experienced by the measuring sensor's on-board temperature sensor exceeds the set-point value (in °C).
Low Temperature	Triggered if the temperature experienced by the sensor block's on-board temperature sensor goes below the set-point value (in °C).
Sensor LED Current	Triggered if the sensor current rises above the set-point value. It is probable that there is likely a problem with the sensor block or the sample chamber is dirty. The set-point for this alarm is configured at the factory and should not be changed.
Sensor Comm.	Triggered if the unit is no longer able to communicate between the motherboard and the sensor block. If this alarm triggers, the unit will no longer function correctly
RTC Battery.	Triggered if the voltage from the on-board clock battery (which maintains the analyzer's real-time clock should the power fail), drops below a hard-coded value. In addition, it will also trigger if the time and date in the real-time clock varies from the time and date of the connected PC by more than a certain amount.
Maximum Tape Advance	Triggered if the motor advances the tape more than a certain number of rotations without getting a corresponding signal from the pulse counter that controls the tape advance. If this alarm triggers, it will generally indicate a problem with the encoder. The length of the maximum tape advance can be set by the user, but it is advised to leave this set at the factory default.
Low Tape	The analyzer can be configured with an optional optical low tape sensor. If this alarm is triggered, it means that the tape is very low and should be replaced soon. The Low Tape alarm, is triggered when there is approximately 15 feet of tape remaining on the reel.
Tape Length	Triggered based on the amount of tape that is calculated to be remaining by the pulse counter. The alarm will trigger when the length of tape calculated to be remaining, in feet, drops below the number set in this field. For this alarm to work correctly, it is essential that the length of tape in the reel be reset to the correct length value (usually 300 or 350 feet) in the Global screen whenever a tape is replaced.

Tape Movement	Triggered if the pulse counter no longer receives any pulses when the tape is advanced by the motor. Tape Movement and maximum tape advance alarms may be triggered by the same problem, so both should be analyzed. Possible causes of a tape movement alarm include tape breakage, jamming of the encoder, and motor failure.
Sensor Calibration	Triggered if the analyzer is unable to adjust the detector output to 1000mV on white tape even after raising the sensor current to the maximum allowable value, the sensor calibration alarm will be triggered. This alarm will typically be triggered if the tape does not move correctly and the stain becomes exceptionally dark before the next analysis begins, or if there is no tape present.
Bypass	Bypass mode is a mode of the analyzer that disables any outputs that may be triggered by alarms and is typically used during service to avoid inadvertent triggering of alarms. However, for normal operation, it is essential that bypass mode be disabled. Thus, the analyzer is equipped with a bypass timeout. When enabled by putting a checkmark in the <i>'Enable'</i> box on the <i>Global</i> tab, bypass mode will automatically be exited by the analyzer after a certain number of seconds after the last keypad button push. The length of the bypass timeout, in seconds, can be set by the user in the <i>Bypass Timeout (s)</i> field. By default, this is set to 450 seconds, and is disabled.
AC Power Alarm	Triggered if the AC power is removed from the system
DC Power Alarm	Triggered if the DC power is removed from the system

8.4 Commonly Observed Problems

Table 8-3 is a list of commonly observed problems that may be encountered during normal operation and servicing of the analyzer

Table 8-3: Troubleshooting Guide

Problem	Cause	Solution
1. Sensor Comm. Alarm	Sensor block connector unplugged or loose	Check that DC voltage (Red & Black wires) at bottom of Sensor block is 10.5V
2. Sensor Calibration Alarm	Sensing tape is not installed.	Install sensing tape between sample chamber and compression head.
	Sample chamber is dirty.	Clean sample chamber.
	Gas is running during the initial start-up calibration	Perform sensor calibration on unstained tape:
3. Tape movement Alarm	Tape is not installed over tape counter roller or tape is broken.	Check that tape path runs over the tape counter roller and is not broken
	Tape roller movement is inhibited	Loosen set screw and move away from plate.
4. Stain is not well defined causing erratic readings.	Compression head not correctly sealing.	Check the seal on the compression head
	Tape not seated properly	Remove tape and reinstall tape
5. Stain is uneven (darker at top or bottom) causing erratic readings.	Compression head not seated properly.	Loosen screws that hold compression head to chassis. Adjust compression head so that it will sit flush against sample chamber and check seal)
6. Stain is normal but readings are still erratic.	Stains have too much overlap	Increase <i>Stain Width In Pulses</i> value in the Tape Box on the Global tab of the GUI by 5 so that the stains are further apart.
	Back pressure on analyzer vent.	Check eductor for proper operation.
	Frozen vent lines due to high humidity in area.	Make sure vent slopes downward.
	Sensor Current is too high. This should be accompanied by a Sensor Current alarm.	Lint in sample chamber causing light blockage. Clean the sample chamber.
7. Stains overlapping each other.	Insufficient pulses per tape advance to allow correct stain spacing.	Increase <i>Stain Width In Pulses</i> value in the Tape Box on the Global tab of the GUI by 5 so that the stains are further apart.

8. Stains unevenly spaced (large gaps between stains). This should be accompanied by a Tape Movement alarm.	Pulse Counter not correctly connected to sensor block.	Check that Pulse Counter connector on the top right corner of the sensor block is correctly connected.
	Pulse Counter not rotating.	Check that the pulse counter capstan is rotating when the tape advances. If not, the pulse counter may need to be replaced.
9. 4-20mA outputs not agreeing with display on the screen.	Ranges are not configured correctly.	Check the analog output range values on the Output tab of the GUI
10. Calibration, Reference, or zero runs are not running after being initiated by keypad or schedule	System in Alarm 1 or PAA condition on Sample Run	Wait until alarm condition has cleared. Calibration, reference, or zero run will then automatically run in the order they were initiated.
11. Sensor LED Current Alarm	Sample Chamber is dirty Analyzer is out of tape Sensor is not calibrated	Re-calibrate the sensor with clean white tape installed. On the keypad hit <i>F4</i> , then <i>F1</i> . Press <i>F4</i> to scroll down the screens to SenCal. You may need to use the <i>F2</i> or <i>F3</i> keys to scroll up or down the screen until SenCal is highlighted. Press the EDIT key and press ENTER key to toggle the parameter to ON. The sensor will calibrate and then automatically go online

Section 9 **Analyzer Q.C. Documentation**

The Galvanic Applied Sciences product quality assurance program is designed to ensure that the system meets all manufacturing specifications and is built to meet the customer's specific requirements. This chapter consists of the form which provides the overall QA procedure and should be retained. The form is completed during the manufacturing process and QA inspection to ensure that the all relevant operations are performed.

Customer Information					
Customer:					
Address:					
City:		Province / State			
Zip/PC:		Country:			
Contact:		Phone:			
P.O. No:		S.O. No:			
Analyzer/ Sensor Serial Number, Software/Firmware Revisions					
Analyzer S.N:		Sensor S.N:			
G.U.I. Version:		Firmware Version:			
Rosetta Version:		Sensor Firmware Version:			
Issued:		Completed:			
Included Options					
Sample System:	Yes <input type="checkbox"/> No <input type="checkbox"/>	Enclosure:		Yes <input type="checkbox"/> No <input type="checkbox"/>	
Gauge Make:	GO PR-1	Gauge Range:		0-30 psig	
Filter Type:	BA0075	Filter Element:		MC0477	
		Set:		15 psig	
Chassis Flow Meter:	BA0328	T.S. Flow Meters:		BA0071	
Auto-Cal Solenoid:	Yes <input type="checkbox"/> No <input type="checkbox"/>				
Flow Meters Set Up					
Sample Set At:	0.5	On Tube Scale			
Global Setting					
Area Classification		Class I, Div. 2 Groups B, C, D <input type="checkbox"/>		Class I, Div. 1 Groups B, C, D <input type="checkbox"/>	
<input type="checkbox"/>	Voltage Input	AC <input type="checkbox"/>	DC <input type="checkbox"/>	DC Back Up <input type="checkbox"/>	
<input type="checkbox"/>	Analysis Type	Standard <input type="checkbox"/>		Timed <input type="checkbox"/>	
<input type="checkbox"/>	Synchronize the Analyzer Time and Date.				
<input type="checkbox"/>	Aperture Strip Size	inches			
<input type="checkbox"/>	Pulse Counter Capstan Diameter Measured	inches			
<input type="checkbox"/>	Number of Pulses on Tape Advance				
<input type="checkbox"/>	Live Sensor LED Current	mA			
<input type="checkbox"/>	Amount of tape used reset:	300 Feet			
<input type="checkbox"/>	Calibrate the Analog outputs				
<input type="checkbox"/>	Wipe Archive and Event logs before shipping				
<input type="checkbox"/>	Bypass Timeout Enabled?	YES / NO			
<input type="checkbox"/>	If Yes... Bypass Timeout Length	Seconds			
<input type="checkbox"/>	Furnace Pulse width	%			

Stream Setting

Stream 1							
<input type="checkbox"/>	Chlorine Range		ppm				
<input type="checkbox"/>	High Alarm 1 Set point		ppm				
<input type="checkbox"/>	High High Alarm 2 Set point		ppm				
<input type="checkbox"/>	AO # 1 Range		AO # 2 Range		AO # 3 Range		
<input type="checkbox"/>	AO # 4 Range		AO # 5 Range		AO # 6 Range		
<input type="checkbox"/>	Sample Delay		Seconds				
<input type="checkbox"/>	Sample Interval		Seconds				
<input type="checkbox"/>	TSC (mV) for Sample Run						
<input type="checkbox"/>	TSC (mV) for Calibration Run				mV		
<input type="checkbox"/>	TSC (mV) for Reference 1 Run				mV		
<input type="checkbox"/>	TSC (mV) for Reference 2 Run				mV		
<input type="checkbox"/>	TSC (mV) for Zero Run				mV		
<input type="checkbox"/>	High Alarm Enabled		Relay #		Solenoid #		
<input type="checkbox"/>	Deviation Enabled		Relay #		Solenoid #		
<input type="checkbox"/>	High High Alarm Enabled		Relay #		Solenoid #		
<input type="checkbox"/>	High-High Alarm Duration Enabled		Relay #		Solenoid #		
<input type="checkbox"/>	Lock Stream Alarm Enabled				ppm		

Final Check and Calibration			
<input type="checkbox"/>	Primary calibration with		ppm Chlorine test gas
<input type="checkbox"/>	Charted for	Hours	
<input type="checkbox"/>	Chart included		
<input type="checkbox"/>	Gain		Zero Offset
<input type="checkbox"/>	Chlorine spanned at	__ mV at __ % of full scale	__ mV at __ % of full scale

Calibration Technician: _____

Date of Calibration: _____

Section 10 Chlorine Analyzer Wiring Book

NOTICE

The wiring book can be accessed by selecting Wiring Book on the Help menu of the application program

Table 10-1: Analyzer Wiring Book Index

Wiring Diagram for	Connectors	Figure
DC Power	P4, P5	10-1
AC Power	P3, P5	10-2
External Furnace	P1, P2, P3, P5	10-3
AC & DC Power	P3, P4, P5	10-4
Solenoid Drivers	P5, P6	10-5
Relays Wiring	P7, P8	10-6
Digital Inputs (Isolated)	P9	10-7
Digital Inputs (Dry)	P10	10-8
Isolated 4-20 mA Outputs	P11	10-9
Isolated 4-20 mA Inputs	P12	10-10
5 and 24 V Stepper Motors	P14	10-11
Isolated 2.5 Mbits/sec LAN Port	P15	11-12
Isolated RS-485 Port	P16	11-13
P17 RS-232 Port to Ethernet Cable	P17	11-14
Division 2 Wiring (Keypad, Sensor, Encoder)	P18	11-15
Non-Isolated 4-20 mA Inputs	P19	11-16

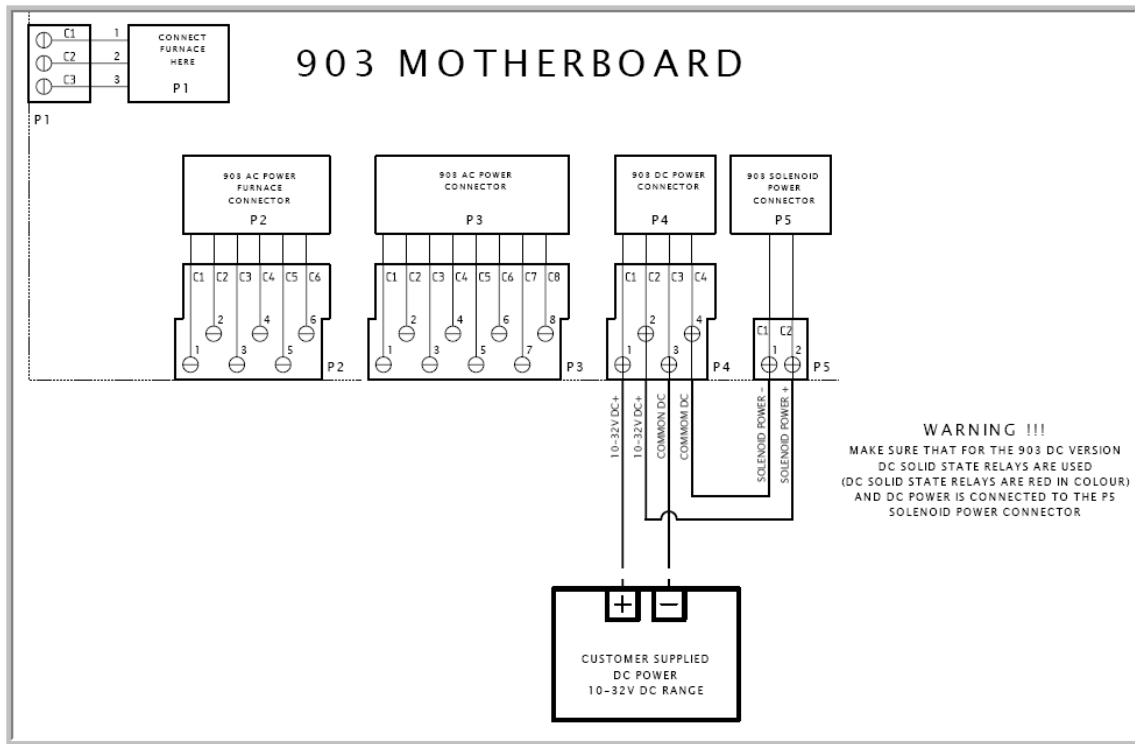

Figure 10-1: DC Power Wiring Diagram

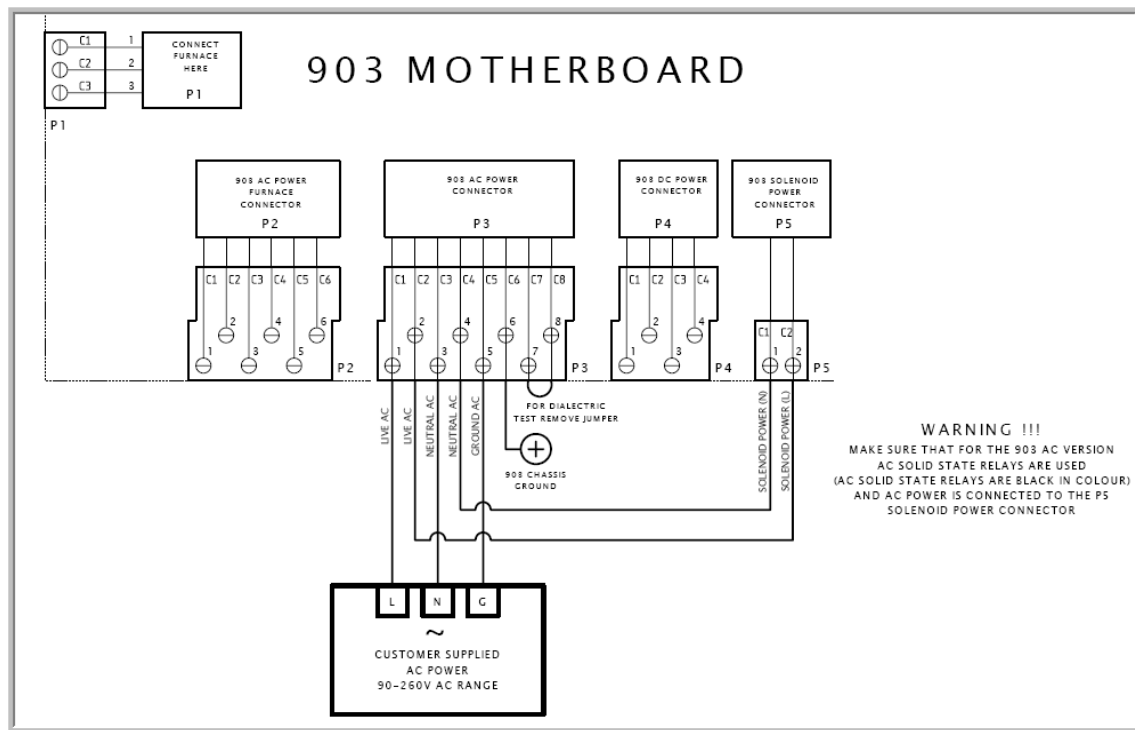

Figure 1010-2: AC Power Wiring Diagram

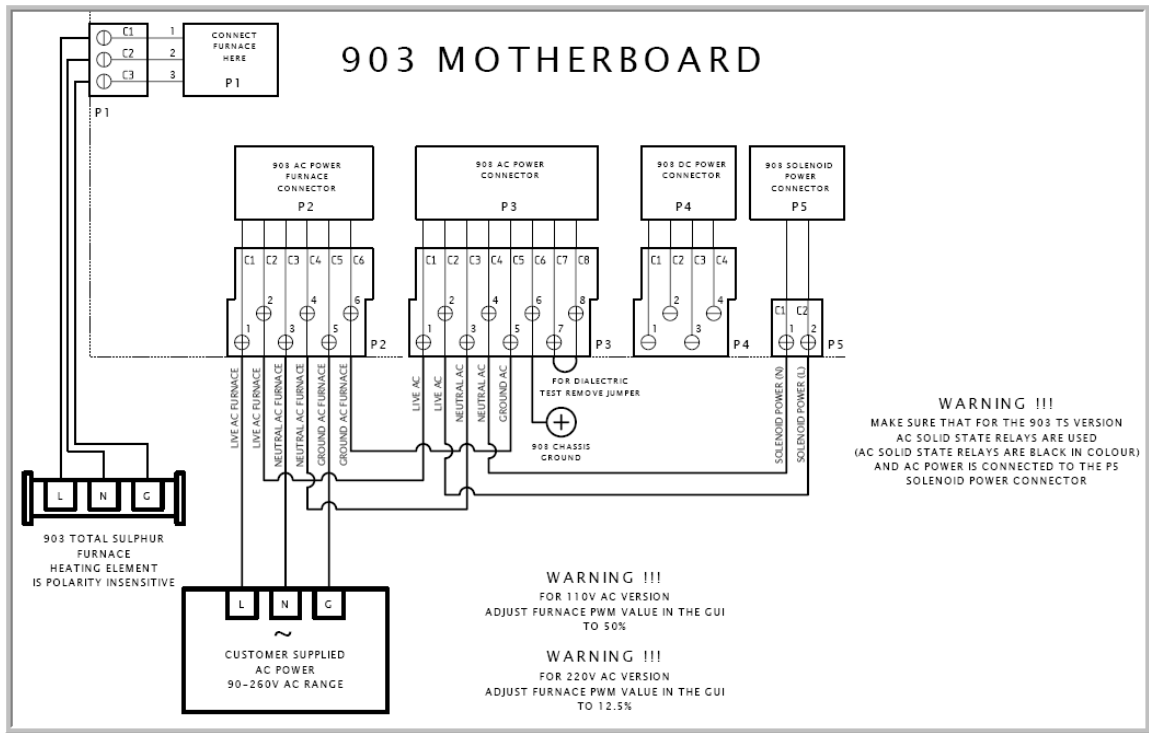

Figure 10-3: External Furnace Wiring Diagram

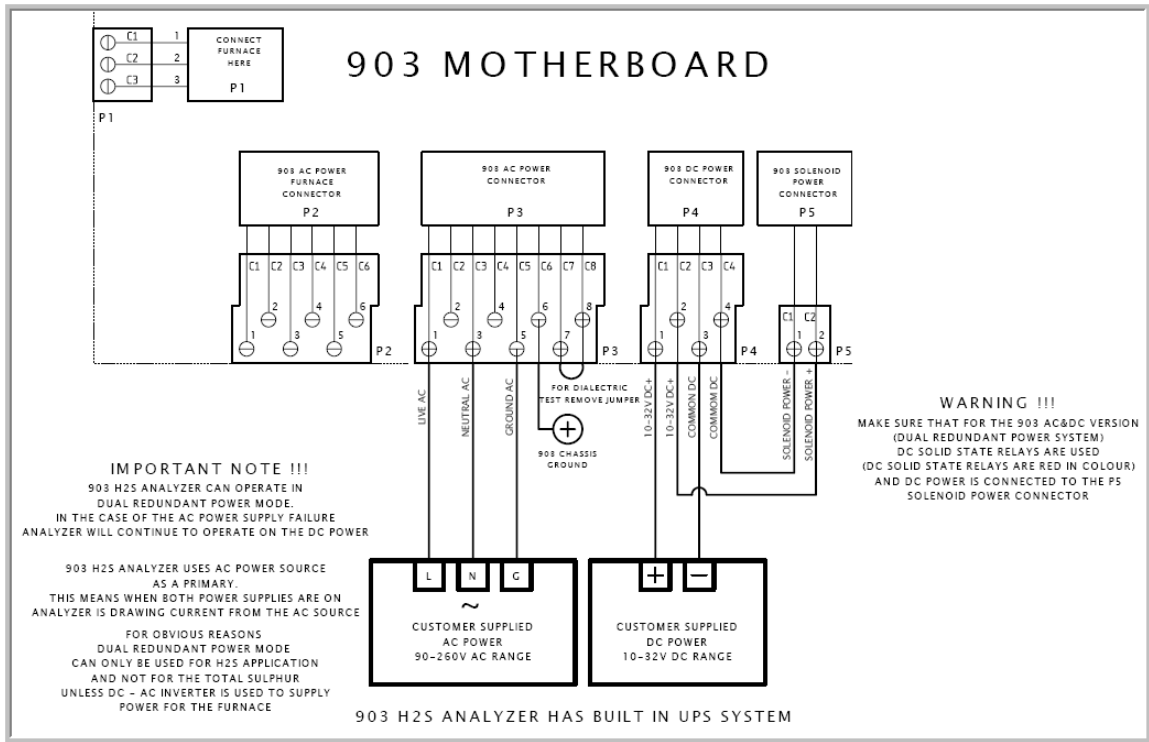

Figure 10-4: AC & DC Power Wiring Diagram

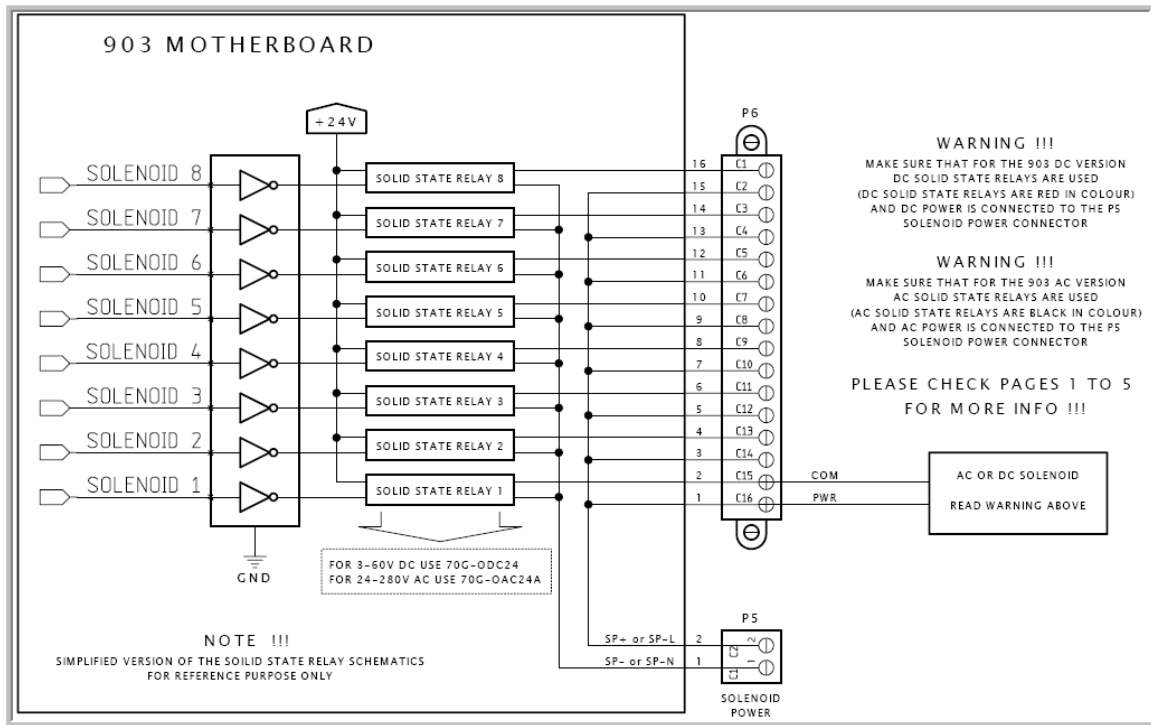

Figure 10-5: Solenoid Drivers Wiring Diagram

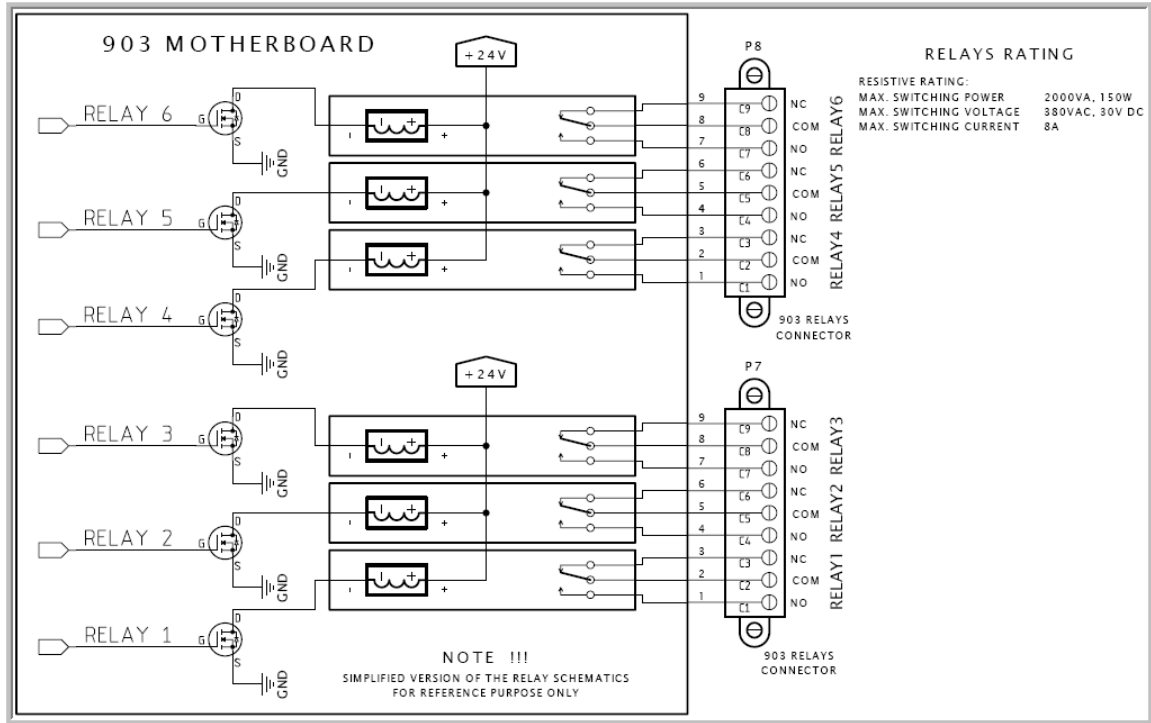

Figure 10-6: Relays Wiring Diagram

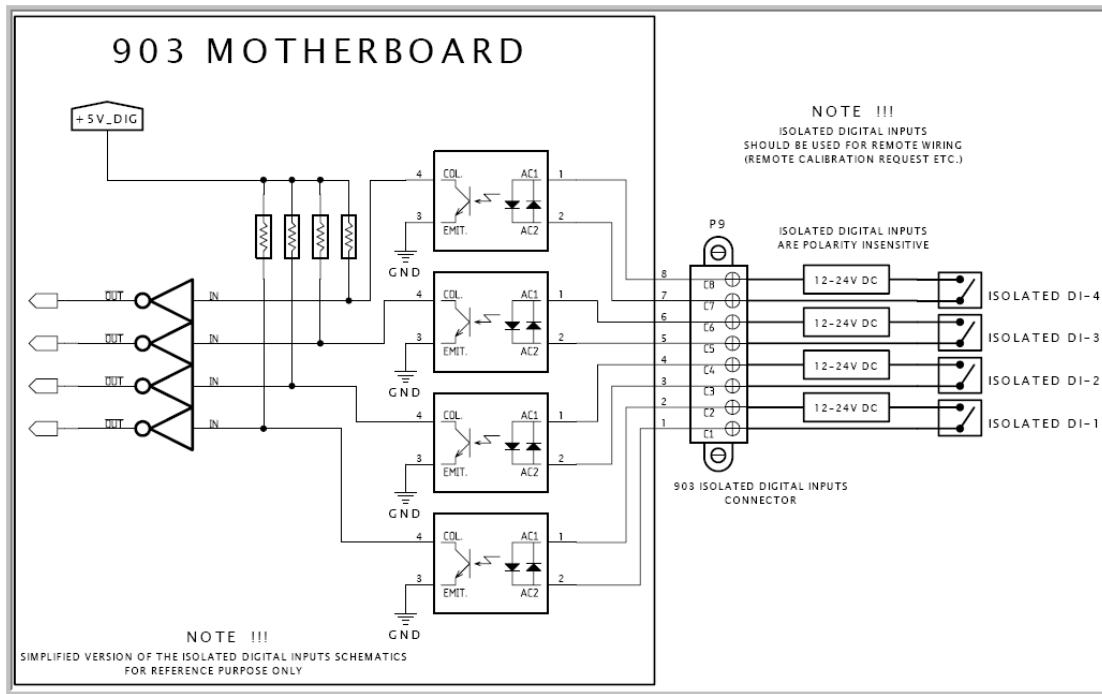

Figure 10-7: Discrete Inputs (Isolated) Wiring Diagram

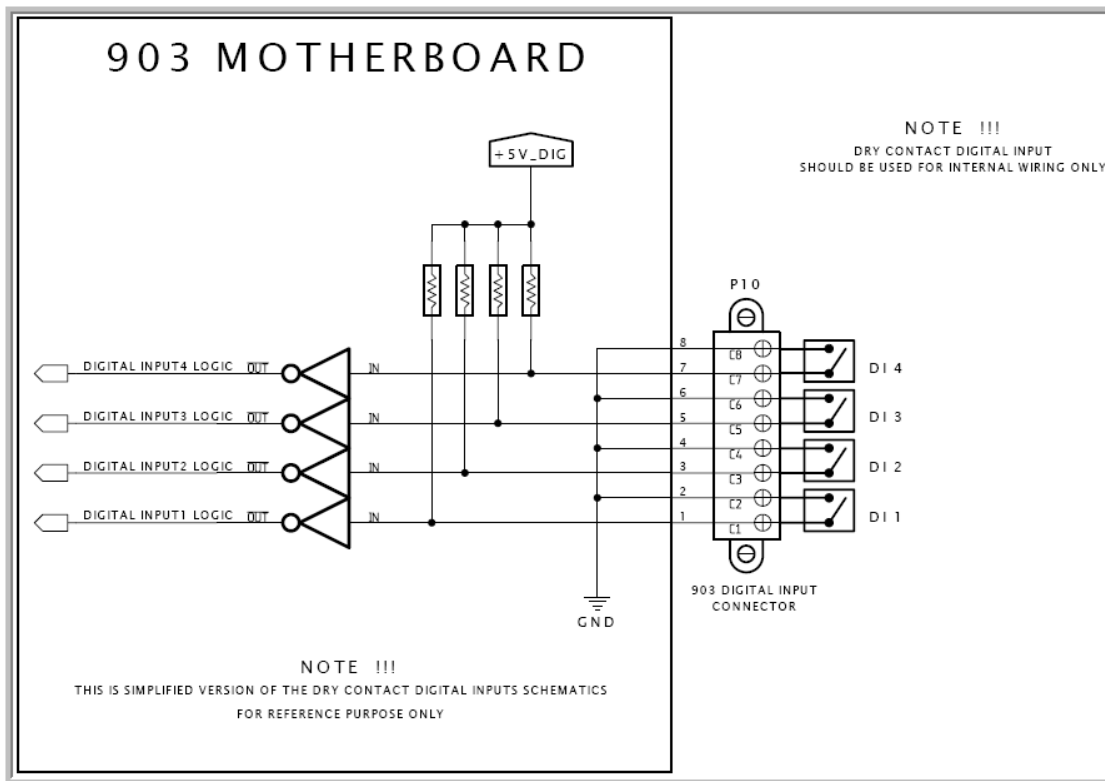

Figure 10-8: Discrete Inputs (Dry) Contact Wiring Diagrams

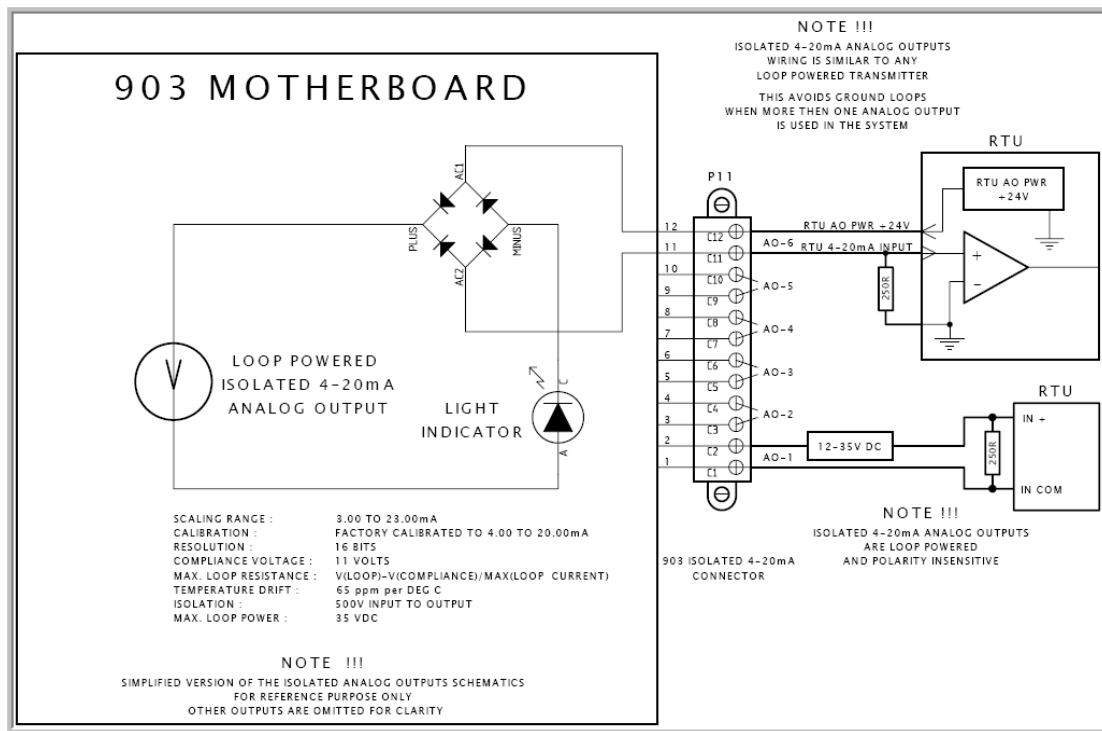

Figure 10-9: Isolated 4 – 20 mA Outputs Wiring Diagram

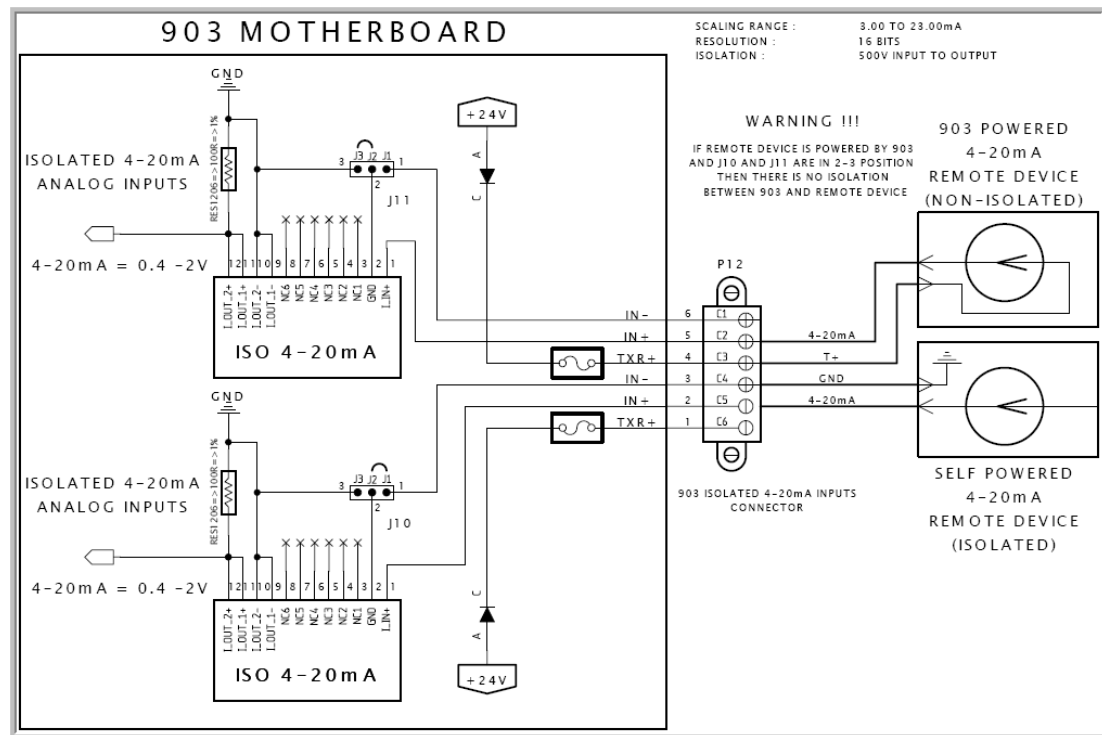

Figure 10-10: Isolated 4 – 20 mA Inputs Wiring Diagram

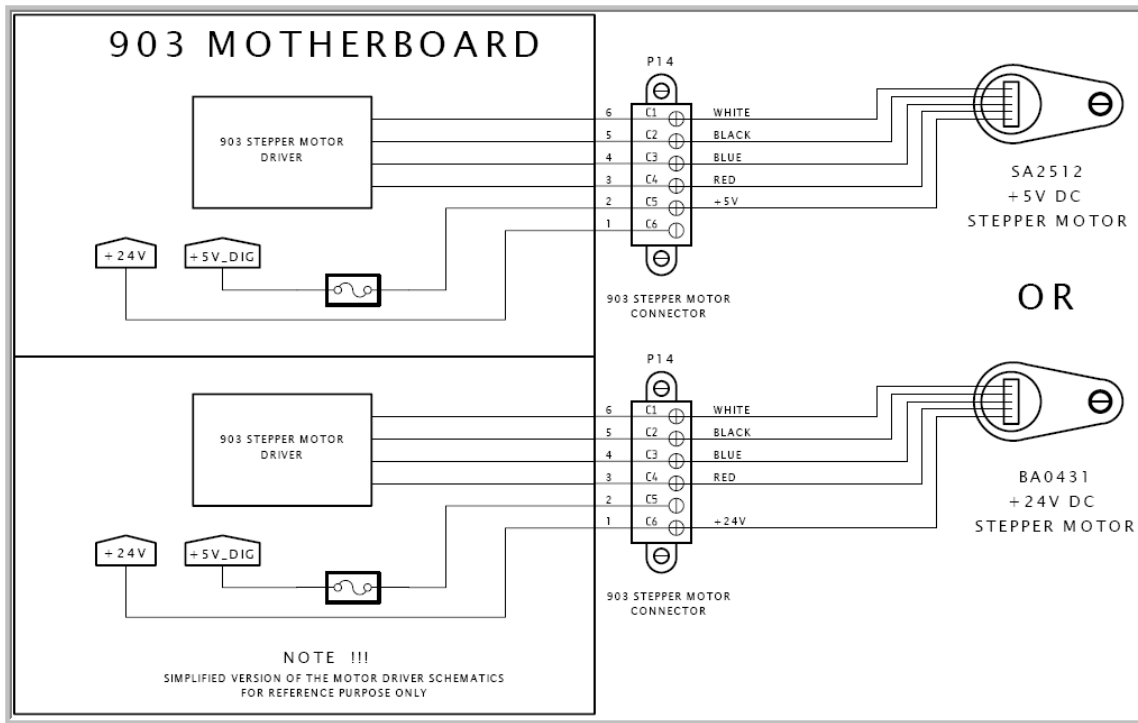

Figure 10-11: 5V and 24 V Stepper Motor Wiring Diagram

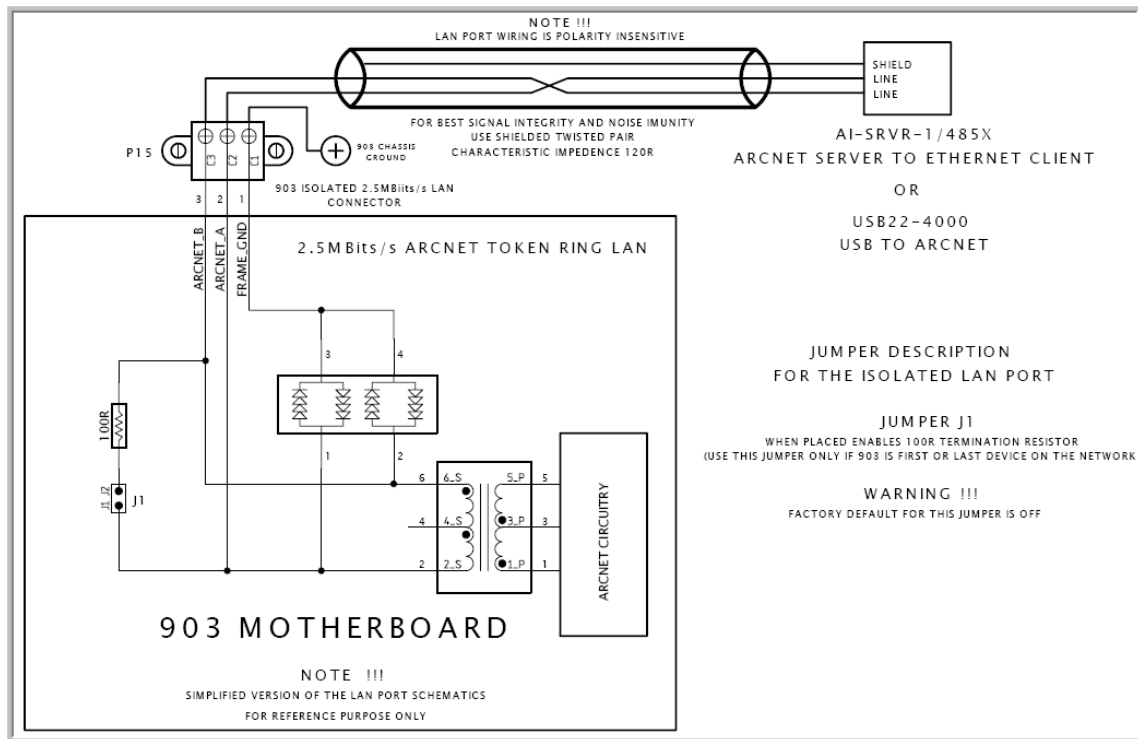

Figure 10-12: Isolated 2.5 Mbts / LAN Expansion Port

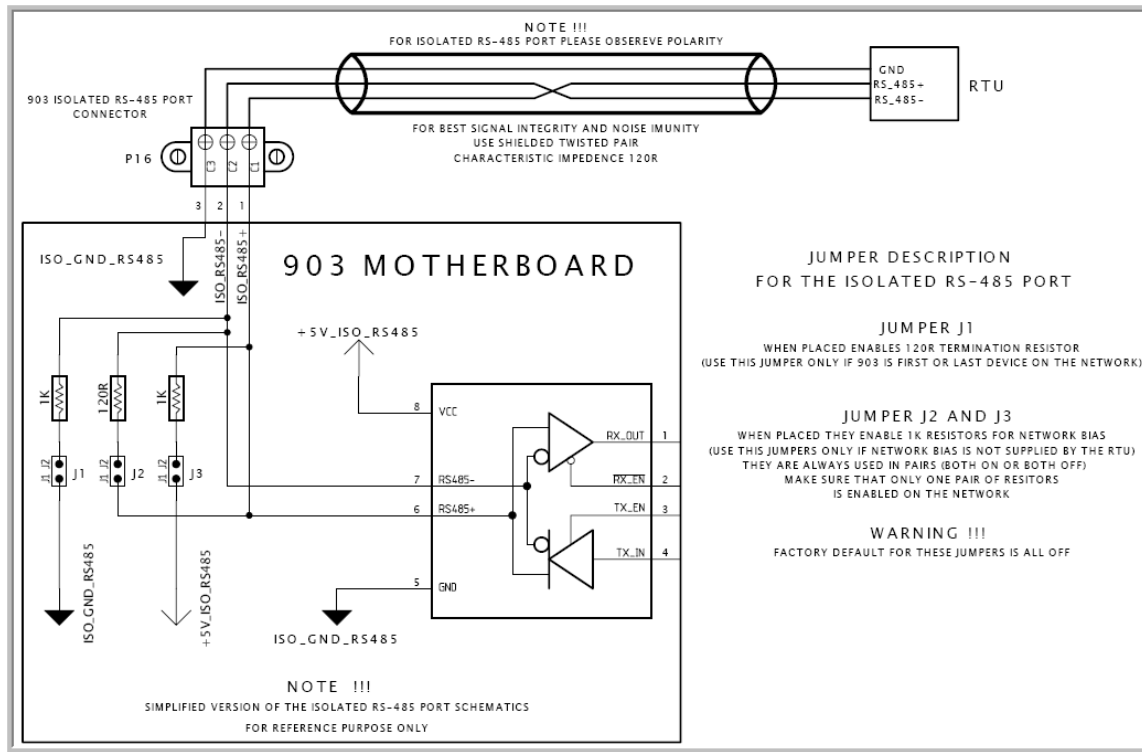

Figure 10-13: Isolated RS - 485 Port

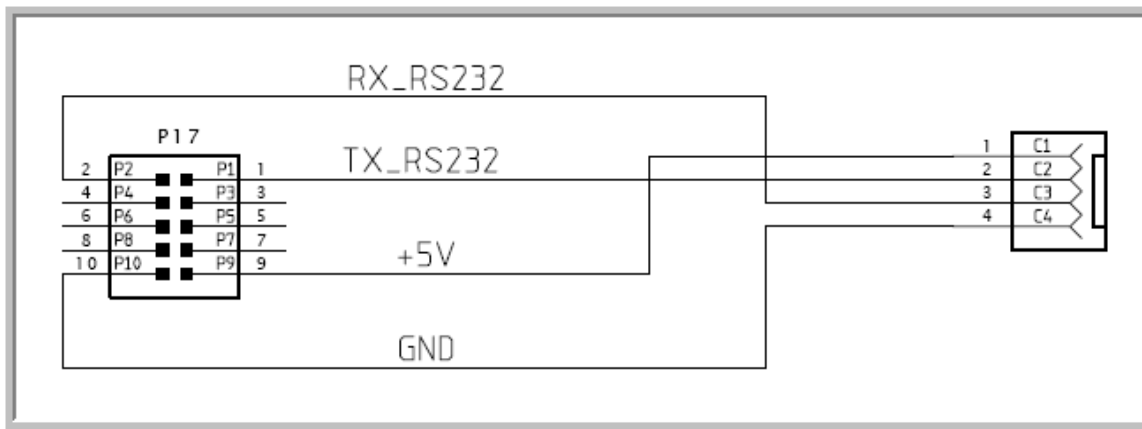

Figure 10-14: P17 RS232 Port to Ethernet Cable

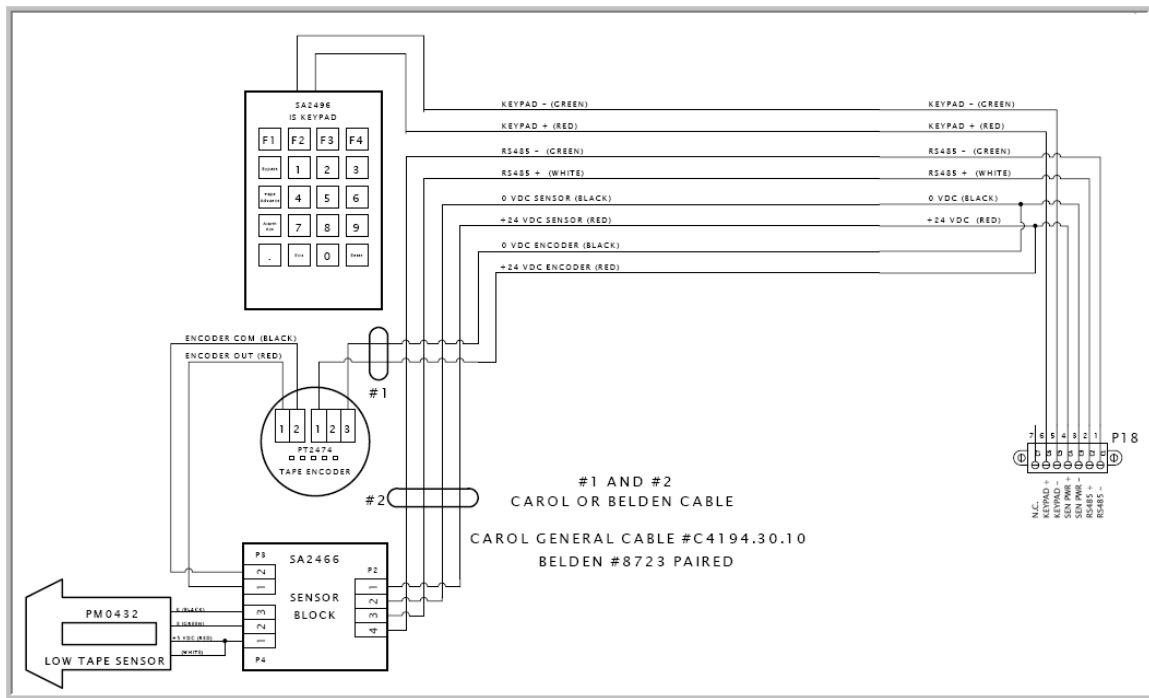

Figure 10-15: Sensor Block, Keypad, Encoder and Low Tape Sensor Div.2 Wiring Diagram

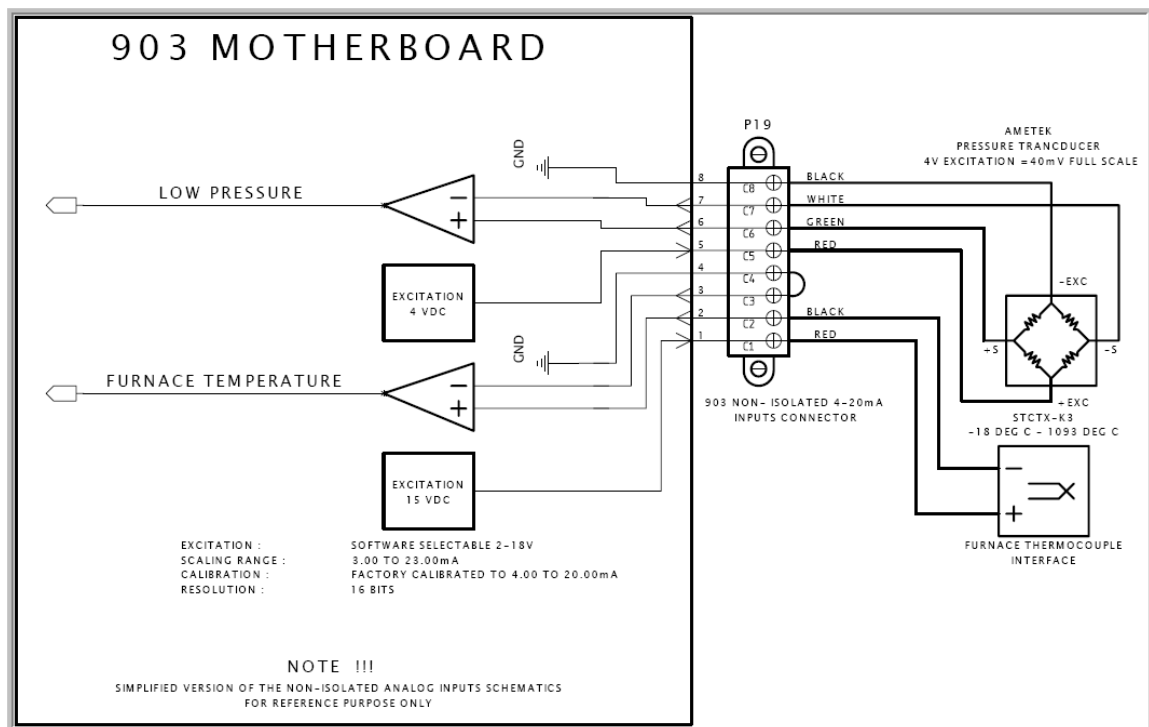

Figure 10-16: Non-Isolated 4 - 20 mA Inputs

Section 11 **Technical Specifications**

11.1 Performance Specifications

Range	0-2000 ppm w/out dilution (consult factory) - 100% w/ dilution
Low Range	0-1 ppm or less (consult factory)
Linearity $\pm 1\%$ of full scale	$\pm 2\%$ of full scale
Repeatability	
Response Time	< 20 sec to alarm; 3 min to 90%
Cycle Time	Time Depends on range and gas concentration. Cycle time is user configurable; typical 4 min.

11.2 Functions

Streams	One includes: Sample analysis run, zero run, reference1 run, reference2 run, calibration run and.
Multi-Range	Each stream can have separate calibration coefficient and range of measurement. Please consult factory for details
Tape Life	5-14 weeks, depending on application. Typical tape life given 3 minute cycle time is 5 weeks. Can be extended to as much 3 months at low concentration.
Auto / Manual Mode	AUTO mode: analyzer runs in predefined sequence. MANUAL mode: user can force any stream to run.

11.3 Communications / Interface

Outputs	<p>6 - 4-20mA outputs (isolated and scaled to range) 3 - SPDT alarm relays 5 amps @ 30 VDC or 8amps @ 120/240 VAC (up to 3 more optional) 1 - 3 amp max 35 VDC or 3A 24-280 VAC Solenoid Driver (standard), up to 7 more (optional) 1 - USB port 1 - RS-232 Serial Port 1 - RS-485 isolated serial Port 1 - LAN Port for extended analog outputs 1 - Ethernet (optional) Modbus communication on all ports</p>
Inputs	<p>8 discrete inputs (4 - Dry contact digital inputs & 4 - wet contact digital inputs (12/24 VDC)) 2 - 4-20 mA, user selected</p>
Operator Interface	<p>128x64 LCD Screen Handheld Keypad (Intrinsically safe keypad for D1 models) 10 visual indicators (LED) for quick status Remote PC application program</p>

11.4 Instrument Specifications

Size	17"H x 19"W x 9"D (430 mm x 480 mm x 230 mm)
Weight	40 lb (18.2 kg)
Power Consumption	25W @ 24VDC 150W @ 110 VAC 150W @ 230 VAC Power Input Dual power design - Universal 100-230VAC and 10-36VDC input. Capable of being attached to redundant power supply
Electrical	CSA C/US Certified
Classification	Class 1, Div 2, Group B,C&D, T3
Ambient Temp.	10-50°C (without enclosure)
Electronics	Dual processor design with intelligent colorimetric sensor. Sensor is using 24 Bit AD converter for greater sensitivity with temperature monitor on sensor block. Sensor automatically calibrates on every cycle to prevent drift. Real time clock for accurate event time stamping. Tape length sensor optimizes tape usage and provides exact measurement of tape used. (reported length is within 1% of actual length) User can program low tape alerts/alarms. Optional independent optical low tape sensor
Software	Windows based software for configuration and monitoring. Software includes advanced configurable features for stream switching, automatic calibration, multi mode H2S measurement, reference and zero gas test, and multi-ranging.
Humidifier	Permeable membrane humidifier system facilitates faster response time and eliminates moisture carry-over to lead acetate tape.
Memory	Field programmable memory Firmware for unit can be upgraded in the field.
Data Logging	Up to 10 months of H2S concentration data logs. 512 Kbytes non-volatile memory for data logging and audit trail
Options	dilution system, high pressure sampling system, solar power, back panel, low pressure sensor, low hydrogen sensor, auto-cal, and enclosure / cabinets (temperature

Section 12 Spare Parts



Use of unauthorized parts may impair suitability of the equipment for Class I, Div 2 locations.

Part Number	Description
AF0365	WHEEL,SUPPLY
AF0367	WHEEL, TAKE-UP
AF0509	SAMPLE CHAMBER, DELRIN
AF0917	CLIP,RETAINING,SENSOR BLOCK
AF1116	SPOOL,TAPE ANALYZER
AF1124	KNOB, SPOOL
BA0071	FLOWMETER - (ROTOMETER W/ADJUSTABLE KNOB) FOR STANDARD ANALYZER
BA0328	FLOWMETER - (ROTOMETER WO/ADJUSTABLE KNOB) FOR STANDARD ANALYZER
BA0423	X-PROOF ROTATING SHAFT/HUB ASSY (For Class I Division 2 Analyzers only)
SA3032	X-PROOF ROTATING SHAFT/HUB ASSY (For ATEX/IECEx Analyzers only)
BA2530	USB COMM CABLE MALE A-A
BA2531	COMM CABLE (USB TO RS-232)
CO3024	CHLORINE SENSING TAPE
FS0188	SHOULDER SCREW
FS1325	SCREW, SUPPLY REEL,902
GP506	"GENIE" MEMBRANE PROBE FILTERS (GP-506) PACKAGE OF 5
MC0406	REAR WINDOW FOR SAMPLE CHAMBER
MC0409	*1/32" RATE/READ APERTURE STRIP *(0-25 PPM AND 0-30 PPM)
MC0410	*1/16" RATE/READ APERTURE STRIP *(0-16PPM AND 0-20 PPM))
MC0411	*3/32" RATE/READ APERTURE STRIP *(0-10 PPM)
MC0412	*1/8" RATE/READ APERTURE STRIP *(0-5 PPM)
MC0477	FILTER REPLACEMENT ELEMENT (SAMPLE SYSTEM UNITS ONLY)
MC0570	0.04" HIGH RANGE RATE/READ APERTURE STRIP*(ONLY ONE SIZE USED PER RANGE)
MC0571	*3/16" RATE/READ APERTURE STRIP *(ONLY ONE SIZE USED PER RANGE)
MC0572	*1/4" RATE/READ APERTURE STRIP *(ONLY ONE SIZE USED PER RANGE)
MC0593	GASKET,WINDOW,REAR,(KEEP FLAT)
MC1814	STAINLESS STEEL UNION,ORIFICE C/W 43 MICRON
MC2526	TAPE ALIGNMENT BUSHING
MM56200	MEMBRANE FOR IRA-4SS
OKIRA4SS	SEAL KIT FOR IRA-4SS PROBE
PM-89-1	PROTECTOR SERIES MEMBRANE REPLACEMENT FILTERS (PKG OF 5)
PM-99-1	MONSTER MEMBRANE REPLACEMENT FILTERS (PKG OF 5)
PT2557	903 DISPLAY BOARD
PT3007	TAPE OPTICAL ENCODER BOARD
RKIRA4SS	REPAIR KIT FOR IRA-4SS PROBE
SA1736	NAFION HUMIDIFIER
SA1811	EDUCTOR ASSEMBLY
SA2193	HUMIDIFIER TUBE REPLACEMENT KIT
SA2512	HURST STEPPER MOTOR 5V W/CONN
SA2560	903 ANALYZER ELECTRONICS ASSEMBLY
SA2561	REMOTE KEYPAD ASSEMBLY (For Class I Division 1 or Class I Division 2 Analyzers only)
SA2992-903	REMOTE KEYPAD ASSEMBLY (For ATEX/IECEx Analyzers only)
SA3005-00	903 DIGITAL SENSOR BLOCK ASSEMBLY
SA3204	COMPRESSION TAPE, ASSY.
	WIRING HARNESS

Section 13 **MSDS Information**

Index

%

% Deviation Enable, 94

A

About dialog box, 62
Accessing Configuration, 121
ACK_AL, 56
Acknowledge All Latches, 63
Action, 99
AIO Menu, 57
Alarms, 94
Alarms menu, 48
ALARMS Page, 53
Alarms Tab, 71, 149
Alerts, 147
ALRM, 48
Analog Input #, 113
Analog Input Alarms, 73
Analog Input Parameters and Controls, 114
Analog Input Tab, 113
Analog Inputs Alarm, 114
Analog Output Override, 93
Analog Outputs, 70, 102
Analysis Alarms, 73
Analysis Tab, 67
Analysis Units, 91
Analyzer Reading Menu, 55
Analyzer Schedule Menu, 55
Analyzing Samples, 136
Aperture Strip, 22
Application Screens, 64
Archive Tab, 74
Area Classification, 30
Auto Calibration, 134
 Manual, 133
Available Run Types, 104

B

Backlight Lock On, 86
BYPASS, 50
Bypass Alarm, 73

C

Cal Gas Concentration, 97
Cal. Correction Enable, 91
Calibrate A. I. #, 114

Calibrating Analog Outputs, 119
Calibrating the Analyzer Outputs, 131
Calibration Gain, 68
Calibration Gain Calculator, 85, 88
calibration run
 initiate, 52
Calibration Tab, 95
Capture Zero, 114
Changing the Tape, 143
Chart Button Functions, 77
Chart Manipulation Options, 77
Chassis, 18
Checking System, 146
COLD_R, 57
Com Port Direct Option, 35
Communicate Toolbar, 62
Communications Settings, 62
Communications Setup dialog box, 35
Compression Head, 24
 Leak Testing, 41
Computer
 Requirements, 31
Configuration
 Accessing, 121
 Editing, 121
Configuration Menu, 56
Connecting Gas, 41
Connecting the System, 33
CSENS, 47
Current adjustment, 47

D

Deviation Alarm, 73
DIAGNOSTICS, 57
Digital Input Manual Sequencer Request
 Enable Checkbox, 105
DIO Menu, 57
Discrete Input (x) Name, 99
Discrete Inputs (Dry Contact), 71
Discrete Inputs (Wet Contact), 71
DISP, 48
Display Board, 33
Display Board Communication Ports, 18
Display menu, 48
Display Menu, 54
Display Menus, 48
dV/dT, 68

E

EDIT, 50

Editing
 Configuration, 121
Eductor, 25
Electrical Requirements, 28
Enables Entire Sequencer Operation, 104
Enron, 110
ENTER, 50
Ethernet option, 36
Ethernet Option, 36
Event Log Memory Usage, 84
Events Tab, 83
EXIT, 50
Exporting Data, 80

F

Factory Tab, 120
Fail - Safe Position, 102
Features, 13
Filtering Data by Date, 78
Filtering Data Numerically, 78
Fixed Time Analysis, 92
Frequency, 93
Front Panel LED's, 44

G

gain, 51
Gain Factor, 91
Gas Requirements, 30
General Toolbar, 64
Global Alarms, 72, 85, 88
Global tab, 85
Graph Format, 75
Graphical User Interface, 13, 59
GUI, 13, 59

H

Help Menu, 62
High Alarm, 51
High Alarm Enable, 94
High High alarm, 51
High Temperature Alarm, 72
High-High Alarm Duration, 95
High-High Alarm Enable, 95

I

IDLE, 47
INIT, 47
Inputs - WET Tab, 100
Inputs- DRY Tab, 98

Installation, 28
Invert Scrolling, 77
IO Menu, 54
ISO 485 Port, 107

K

Keypad, 16
 Installation, 38
 Using, 49

L

LCD Display Board, 16
Leak Testing
 Compression Head, 41
Live mV Enable, 86
Live PPM Enable, 86
Location of the System, 28
Lock Alarm, 73
Lock Alarm Enable, 95
Lock Stream alarm, 51
Log Daily, 81
Log Hourly, 81
Log On Run, 81
Log Setup, 80
Logon, 60
Low Tape Alarm, 72
Low Temperature Alarm, 72

M

Main Page, LCD, 46
Maintenance, 142
Maintenance Tab, 117
Manual Calibration, 132
Manual Sequencer, 106
Manual Sequencer Request Checkbox, 105
Maximum Tape Advance, 72
Maximum Tape Advance Limit, 88
Menu Bar, 61
MODBUS ADD, 56
Modbus Address field, 36
Modbus Tab, 108
MODEM, 107
Modem Option, 35
Modicon 16, 111
Modicon with Floating Point, 111
Motherboard, 16
MSEQ Menu, 58

O

- Open Application Program, 34
- Operating
 - Controller Module, 44
- Operating the System, 121
- Operation
 - Monitoring, 138
- Operation Toolbar, 63
- Others* Menu, 61
- Output Tab, 101
- Overview, 12

P

- PAA, 68
- Permanent Configuration Write to the Analyzer, 66
- Permanent Write Configuration to Analyzer, 63
- Polarity, 99
- Poll Page Once, 63
- Ports Tab, 107
- Power Eductor
 - Connecting, 42
- Power Supply, 16
- Power up, 32
- Power Vent, 25
- PRG, 47
- Principle of Operation, 12
- Print Orientation, 77
- Print Sizing, 77
- Problems
 - Commonly Observed, 152
- Pulse Counter, 20
- Purge Time, 86
- Purging, 47

Q

- Q.C. Documentation, 154

R

- Rate/Read Aperture Strip, 22
- Raw Zero*, 114
- Read Only*, 60
- Read Only* mode, 37
- Rear Window Assembly, 22
- Receiving the System, 28
- Reference run
 - Initiate, 52
- Reference Tab, 96

- Relays, 70
- Reset Default Colours, 77
- Rotameter, 25
- Routine Maintenance, 142
- RTC Battery*
 - Alarm, 72
- Run Counter, 68
- Run Selector, 99

S

- Safety Guidelines, 9
- Safety Symbols, 8
- Sample Chamber Assembly, 21
- Sample Conditioning System, 26
- Sample Delay, 47
- Sample Interval, 47
- Save as Legal CSV*, 80
- Save as Packet CSV*, 80
- Save as XLS*, 80
- Save Configuration to a new file, 64
- Save Current Configuration, 64
- Scale Manually, 77
- Scale to Data, 77
- Scaled Span*, 114
- Schedule, 116
- SD, 47
- Select Mode* dialog box, 60
- Select Mode Dialog Box, 37
- Selecting Parameters, 122
- SEN. CAL, 57
- Sensing Tape
 - Installation, 38
- Sensor Block, 23
- Sensor Calibration Alarm*, 73
- Sensor Comm Alarm*, 72
- Sensor LED Current, 68
- Sensor LED Current Alarm*, 72
- Sensor LED current alarm limit is, 88
- Sensor Temperature, 68
- Sequencer Items, 104
- Sequencer State, 68
- Sequencer Tab, 103
- Serial Port, 107
- Service, 147
- Set Background Colour, 77
- Set Communication Parameters, 34
- Set Trace Colour, 77
- Show Statistics, 77
- SI, 47
- soft keys, 46
- Software
 - Installation, 31

Solenoids, 102
Specifications, 166
SQNC Menu, 54
Stain Appearance, 43
Stain Width, 87
Stain Width per Pulse, 87
Status Bar, 65
Status Indicator Lines, 47
Status Tab, 70
Stream Calibration Used, 94
Stream menu, 48
Streams Menu, 51
Streams Tab, 89
STRM, 48
Supply and Take-up Reels, 19
Switching Field, 93
Synchronize Time, 63
System Menu, 61

T

TA, 47
Table Format, 74
Tabs, 64
Take-up Reels, 19
TAPE, 56
Tape advance, 47
Tape Advance, 63
Tape Field, 87
Tape Length Alarm, 72
Tape Length Limit, 88
Tape Movement Alarm, 72
Tape Remaining, 68
Tape Saturation Cut-off (TSC), 92
Tape Transport System, 19
Temporary Write to Analyzer, 63

Testing the Analyzer, 43
Timed Analysis Enable, 91
Timers Tab, 115
Timing Commands, 91
Tool Bar, 62
Trend Filter Length, 86
Trended Reading, 68
Troubleshooting Messages, 147

U

Universal Gas Run Commands, 91
Unpacking, 30
Update mode, 37
Update Mode, 61
Update Mode command, 60
Upgrade Firmware, 63

V

Validating the Analyzer Outputs, 131
View Menu, 61

W

Wiring Book, 157
Write Current Page to Analyzer, 66

Z

Zero Correction Enable, 91
zero offset, 51
Zero Offset, 68, 91
Zero Tab, 96

